



GLASS EXPANSION

Quality By Design

ICP-OES/ICP-MS Supplies & Accessories Catalogue

Issue 10



Nebulizers

Introduction to Glass Expansion Nebulizers	1
Nebulizer Types	1
Glass Expansion Nebulizer Part Numbers Explained	1
Learn about Glass Expansion Nebulizers	2
Nebulizer Selection Guide	3

Spray Chambers

Introduction to Glass Expansion Spray Chamber	4
Spray Chamber Types	4
Helix CT - Interface Between Nebulizer and Spray Chamber	4
HydraMist Simultaneous Cold Vapor/Pneumatic Nebulization Spray Chamber	5
Spray Chamber Selection Guide	6

Torches

RF Coils and ICP-MS Cones	8
---------------------------------	---

Accessories

IsoMist XR Programmable Temperature Spray Chambers	9
Guardian In-Line Particle Filter	10
Guardian In-Line Non-Return Gas Filter	10
Eluo Nebulizer Cleaning Tool	11
Trident CT In-Line Reagent Additions Kit	11
Elegra Argon Humidifier	12
Single-Cell Sample Introduction System for ICP-MS	12
Laser Ablation	13
Autosampler Probes	14

Agilent Technologies®

7900	ICP-MS	15
8900	ICP-MS	18
7800/7850	ICP-MS	21
7700/8800	ICP-MS	24
5800/5900 SVDV/VDV/RV	ICP-OES	27
5100/5110 SVDV/VDV/RV	ICP-OES	27
700-ES Axial	ICP-OES	29
700-ES Radial	ICP-OES	32

PerkinElmer®

NexION 1000/2000	ICP-MS	35
NexION 300/350	ICP-MS	37
Avio 200/500	ICP-OES	40
Optima 8000/8300 DV	ICP-OES	42
Optima 4000/5000/7000 DV	ICP-OES	44
Optima 4000/5000/7000 V	ICP-OES	46

Shimadzu®

2030	ICP-MS	48
9000/9800 and 7500/8100	ICP-OES	50

Spectro™

Arcos II EOP/ Blue EOP/TI & Green TI	ICP-OES	53
Arcos II SOP/ Blue SOP & Green SOP/DSOI	ICP-OES	55

Thermo Fisher®

Q/RQ/TQ	ICP-MS	57
PRO Duo	ICP-OES	59
PRO Radial	ICP-OES	61
6000/7000 Duo	ICP-OES	63
6000/7000 Radial	ICP-OES	65

Fittings and Connectors

Nebulizer Fittings and Connectors	67
Spray Chamber/Torches Fittings and Connectors	68

Pump Tubing

Standard Peristaltic Pump Tubing	69
Contour Flared End Peristaltic Pump Tubing	72

Introduction to Glass Expansion Nebulizers

The nebulizer is a critical component of your ICP sample introduction system, so why not opt for the highest quality? Glass Expansion has been manufacturing ICP nebulizers since the early 1980s and continually updates nebulizer designs to improve performance and ease of use. Our proprietary designs include a thick walled VitriCone capillary, UniFit sample line connector and the Direct Connect (DC) product line.

Whether your ICP laboratory is analyzing clean aqueous samples, samples containing HF and/or high dissolved salts, or volatile organic solvents; Glass Expansion has a nebulizer to suit your needs. Learn about the performance advantages and overall difference in construction quality that a Glass Expansion nebulizer can provide your ICP laboratory.

Nebulizer Types

Nebulizer	TDS (%)	Particulates (µm)	HF	Precision	Purity	Material
SeaSpray MicroMist Conikal Slurry Quartz SeaSpray	20 15 5 1 20	75 40* 75 150 75	No No No No No	High High High High High	Good Good Good Good Excellent	Glass Glass Glass Glass Quartz
OpalMist	15	75*	Yes	High	Excellent	PFA
DuraMist	30	75*	Yes	High	Good	PEEK
VeeSpray	30	300	Yes	Moderate	Good	Ceramic

* Varies with nebulizer uptake

Glass Expansion Nebulizer Part Numbers Explained

Glass DC Nebulizers

Conikal

1mL/min uptake

A13-07-UC1



A#-yy-**ZZ**nnn

- A** Gas pressure rating of 40 psi
- #** Gasline fitting type eg:
13 = Suitable for Agilent® 5100/5110/5800/5900
- yy** The argon flow in L/min eg. 07=0.7L/min
- ZZ** Nebulizer model type:
 UC = Conikal U-Series nebulizer
 US = Slurry U-Series nebulizer
 USS = SeaSpray U-Series nebulizer
 UM = MicroMist U-Series nebulizer
 CV = Ceramic VeeSpray v-groove nebulizer
 DM = DuraMist HF resistant nebulizer
 PFA = OpalMist PFA HF resistant nebulizer
- nnn** Aspirated uptake at nominal argon flow, in mL/min eg:
 UC1 = 1mL/min
 UM04 = 0.4mL/min
 PFA005 = 0.05mL/min

Learn About Glass Expansion Nebulizers

All Glass Expansion concentric nebulizers use the unique VitriCone™ construction delivering the best possible precision.

DC Nebulizer



The DC (Direct Connection) nebulizer has a UniFit sample connector which slides easily over the sample arm and an argon connector configured to connect directly to your ICP.

DC Nebulizer Benefits:

- Inert metal-free argon connector.
- Instrument-specific Direct Connect flexible argon line.
- Reliable ratchet fitting ensures leak-free gas connection.

DC versions of the SeaSpray, MicroMist, Conikal, Slurry, DuraMist, OpalMist and VeeSpray nebulizers are available to suit the most common models of ICP-OES and ICP-MS.

The DC nebulizer part number has a prefix specific to each type of gas connector. For example, the prefix "A13-" denotes a connector for the Agilent® 5100/5110/5800/5900 ICP-OES, so part number A13-07-USS2 is a SeaSpray nebulizer configured for direct connection to the Agilent® 5100/5110/5800/5900.

In addition to these unique benefits, the DC nebulizer shares the following benefits with the U-Series nebulizer:

- Resists blockage: The sample channel is uniform from the entry point to the tip, so there is nowhere for particulates to be trapped.
- Fast washout: Since there is nowhere for sample to be trapped, the fastest possible washout and highest sample throughput is achieved.
- Simple to use: Our proprietary UniFit connector slides easily over the sample arm and creates an excellent seal.
- Full length VitriCone construction: With the VitriCone design, the sample channel is constructed from heavy glass capillary which is machined to very high tolerances.



DC Nebulizer Gas Fitting Connectors

Agilent® Vista/700-ES, 4100/4200	70-803-0969
Agilent® 4500/7500	70-803-1086
Agilent® 7700/7800/7900/8800/8900	70-803-1105
Agilent® 5100/5110/5800/5900	70-803-1105
Analytik Jena® ICP-MS	70-803-0969
Analytik Jena® ICP-OES	70-803-1105
Horiba® Jobin Yvon (All models)	70-803-1105
Leeman (All Models)	70-803-0969
Nu Instruments ICP-MS	70-803-1858
PerkinElmer® ICP-OES	70-803-1070
PerkinElmer® Elan/NexION 300/350	70-803-1049
PerkinElmer® NexION 1000/2000/5000	70-803-1449
Shimadzu® (All models)	70-803-1311
Spectro™ (All models)	70-803-1070
Thermo® PRO, 6000/7000, Q/RQ/TQ & X-Series	70-803-1292
Thermo® Neptune	70-803-1468

U-Series Glass Concentric Nebulizers

SeaSpray, MicroMist, Conikal and Slurry U-Series nebulizers are available to suit all common models of ICP-OES and ICP-MS. Each U-Series nebulizer is supplied with a UniFit sample connector.

U-Series nebulizers can be identified by the letter 'U' in the part number, eg. ARG-07-USS2 or ARG-1-UM04.



All glass concentric nebulizers in this catalog are U-Series nebulizers.

U-Series Quartz Concentric Nebulizers

The Quartz SeaSpray concentric nebulizer is made from ultra pure quartz and offers outstanding nebulization efficiency for trace level analyses. It offers freedom from clogging while nebulizing solutions to the limit of solubility of most mineral salts, and conferring significant sensitivity gains. It is specifically designed for ultra trace level analysis.





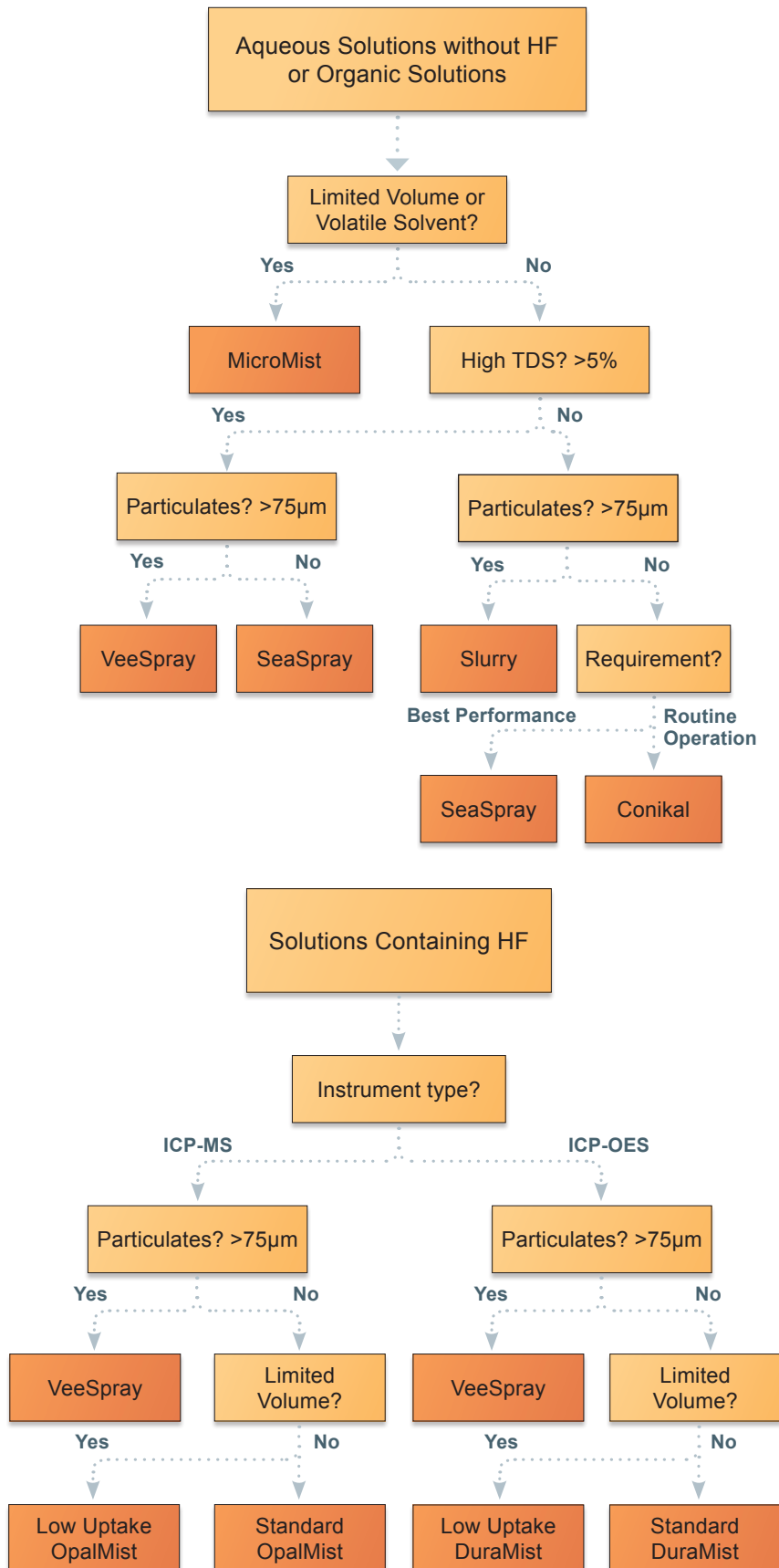



Nebulizer Selection Guide



Introduction to Glass Expansion Spray Chambers

The spray chamber is a crucial component of the ICP sample introduction system since it has a profound effect on transport efficiency, precision, and washout. Glass Expansion revolutionized the spray chamber design for the ICP industry with the Tracey and Twister cyclonic spray chamber, providing improved efficiency and reduced washout. Glass Expansion's unique Helix CT nebulizer interface, provides a zero dead volume seal that results in higher throughput compared to non-Glass Expansion designs.

Spray Chamber Types

Tracey		Internal Volume, mL: 50 Internal Baffle: No HF-resistant: No Precision: Very Good Purity: Good Material: Glass
Twister		Internal Volume, mL: 50 Internal Baffle: Yes HF-resistant: No Precision: Excellent Purity: Good Material: Glass
Cinnabar		Internal Volume, mL: 20 Internal Baffle: No HF-resistant: No Precision: Very Good Purity: Good Material: Glass
Twinnabar		Internal Volume, mL: 20 Internal Baffle: Yes HF-resistant: No Precision: Very Good Purity: Good Material: Glass
Tracey TFE		Internal Volume, mL: 50 Internal Baffle: No HF-resistant: Yes Precision: Good Purity: Good Material: PTFE
Twister TFE		Internal Volume, mL: 50 Internal Baffle: Yes HF-resistant: Yes Precision: Very Good Purity: Good Material: PTFE
Tracey PFA44		Internal Volume, mL: 44 Internal Baffle: No HF-resistant: Yes Precision: Good Purity: Excellent Material: PFA

Helix CT - The Modern Interface Between Nebulizer and Spray Chamber



Traditionally, ICP-OES and ICP-MS sample introduction systems have relied on o-rings to form a gas-tight seal between the nebulizer and spray chamber. There are several drawbacks with an o-ring seal, such as:

- Potential for contamination due to dead volume around the o-ring seal
- Chemical resistivity of strong acids and organic solvents
- The o-rings are difficult to replace, often requiring tools
- Bonding to the nebulizer can result in breakage

Glass Expansion Helix CT spray chamber with ConstantTorque technology, provides a constant, reproducible, inert, gas-tight seal between the nebulizer and spray chamber.

The main feature of the Helix CT spray chamber is the Helix locking screw with built-in torque control mechanism that allows for a consistent seal of the PTFE ferrule against the nebulizer –making it impossible to overtighten or undertighten while ensuring a gas-tight seal each and every time.

A PressFit PTFE ferrule provides a chemically inert seal around the nebulizer, which is immune to strong acids and organic solvents routinely used in ICP sample preparation.

The Helix CT cyclonic spray chamber by Glass Expansion, therefore, eliminates all the drawbacks of the o-ring nebulizer seal, while improving user safety by preventing broken nebulizers.

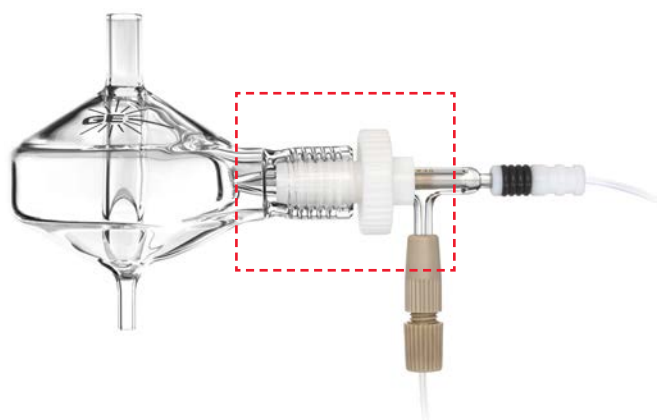

HydraMist Simultaneous Cold Vapor/ Pneumatic Nebulization Spray Chamber

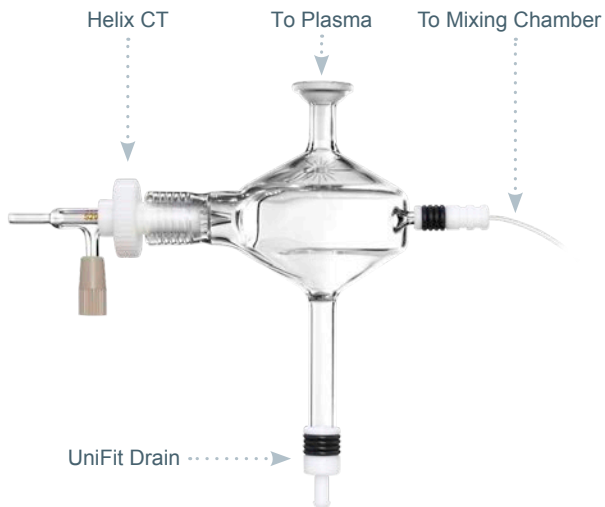

* Note: Nebulizer is not included in HydraMist Kit.

The Glass Expansion HydraMist is a sensitive, simple-to-use spray chamber for Inductively Coupled Plasma (ICP) that allows simultaneous operation of both conventional pneumatic nebulization and cold-vapor/hydride generation. Cold vapor generation can provide more than 10-fold improvement in sensitivity on ICP for cold vapor forming elements such as As, Sb, Se, Tl and Hg. The generation of volatile species of these elements results in increased analyte loading of the analytical plasma giving lower detection limits.

The design of the HydraMist spray chamber is based upon Glass Expansion's industry-standard cyclonic spray chamber, giving excellent sensitivity and short-term analytical precision with fast washout. The HydraMist spray chamber features a secondary inlet port that mixes the aerosolized sample and liquid reductant inside the spray chamber for rapid conversion of the As, Sb, Se, Tl and Hg analytes into volatile hydride species. The unique drain design ensures fast, complete removal of waste from the spray chamber, eliminating excess hydrogen build-up that causes sample reflux degrading analytical precision.

The HydraMist Spray Chamber Features:

- The same outstanding short-term analytical precision and washout as other Glass Expansion cyclonic spray chambers
- Fast and complete vapor phase formation of volatile As, Se, Sb, Tl and Hg species for the best detection limits in hydride generation mode
- A unique drain design to eliminate hydrogen build-up and sample reflux that degrades short-term precision
- Economic, just replace your current spray chamber and keep your existing nebulizer
- Improve productivity by analysing non-hydride forming elements and cold vapor elements simultaneously, avoiding system shutdowns to change over between the hydride generator accessory and conventional pneumatic nebulization

HydraMist Kit

Agilent® 5100/5110/5800/5900	KT-1157
Agilent® 7700/7800/7900/8900	KT-1168
Analytik Jena® PQ 9000	KT-1157
PerkinElmer® Avio 200/500	KT-1157
PerkinElmer® Optima 8000/8300 DV	KT-1162
PerkinElmer® Optima 4000/5000/7000 DV	KT-1162
Shimadzu® ICPE 9000/9800	KT-1157
Spectro™ Arcos II SOP/EOP and Blue EOP/SOP	KT-1160
Thermo® PRO	KT-1160
Thermo® Duo 7600	KT-1156
Thermo® Duo 6000/7200/7400	KT-1179

Spray Chamber Selection Guide

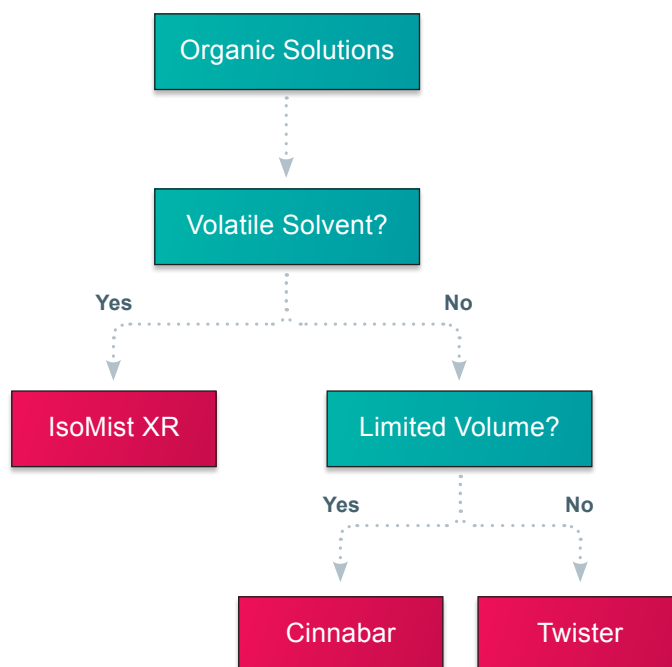
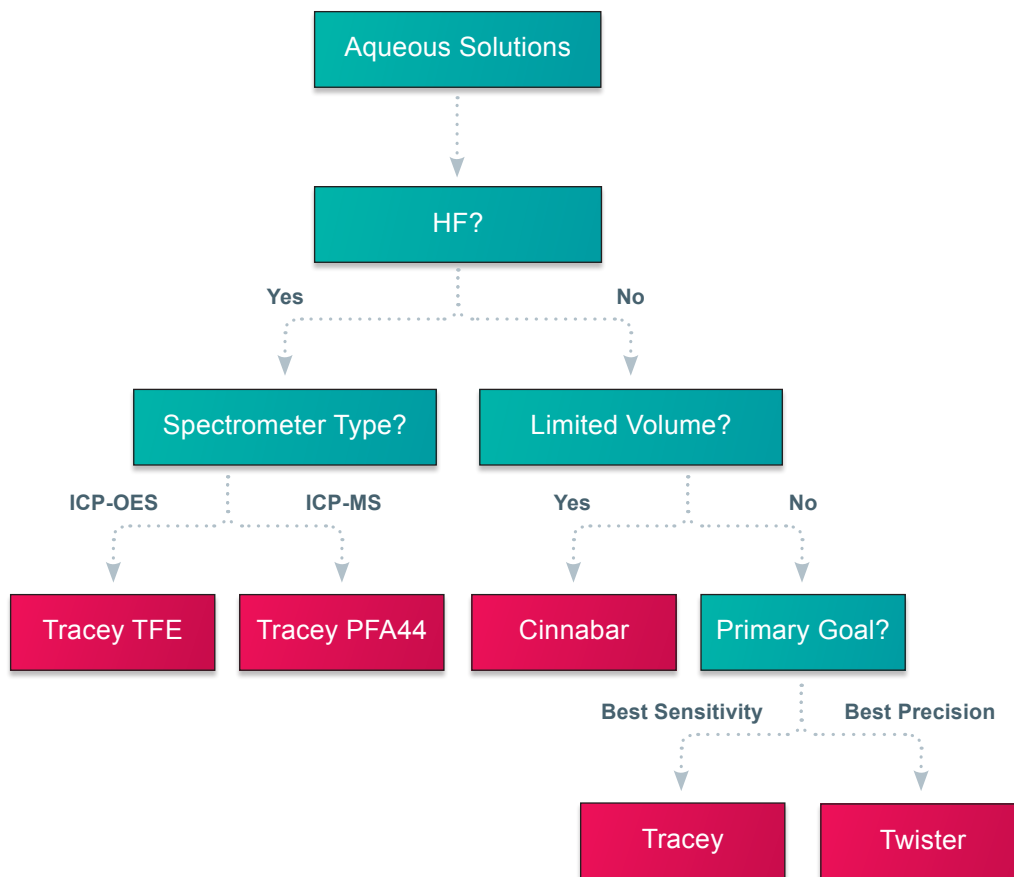

D-Torch (Demountable Torch)

The D-Torch is a revolutionary new demountable torch design. It provides the benefits of a fully demountable torch at a significantly lower cost. Interchangeable outer tubes made of quartz or ceramic are available. The quartz tube is ideal for most aqueous applications and, since the outer tube is usually the first to wear, you can make a significant saving by replacing just the outer tube rather than the whole torch.

The ceramic outer tube is of particular benefit for the analysis of samples with high salt content or wear metals in engine oils, where quartz outer tubes often suffer from short lifetime. The ceramic outer tube has a much longer lifetime, greatly reducing interruptions and downtime due to torch failure. The D-Torch uses the same mounting system as the standard fixed torch so there is no additional cost or complexity to install it.

- Demountable outer tube – why replace the entire torch when just the outer tube wears?
- Interchangeable quartz and ceramic outer tubes.
- Much lower cost than other demountable torches.
- Interchangeable injectors for aqueous, organics, high dissolved solids or HF applications.

* The D-Torch is covered by US Patent 8,232,500 B2

The D-Torch models suited for the Agilent® 5100/5110/5800/5900, PerkinElmer® Avio 200/500, Thermo® PRO and Spectro™ Arcos II and Blue incorporate the same easy to use, self-aligning and locking features of the standard torch in a robust cost effective design.

Complete D-Torch



Injectors



Outer Tubes

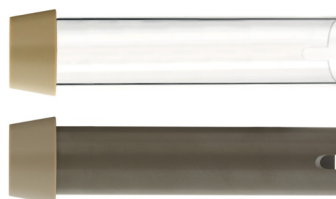

Torch Body



Semi Demountable Torch



- Highly accurate construction
- Lower running cost than one-piece torches

Usually comprises a quartz torch body, a torch adaptor, an injector and GazFit connectors. All these parts are replaceable, making the semi demountable torch more cost effective than the fixed quartz torch. The design of the torch for standard analyses and HF analyses is the same, with only the injector material changing. For aqueous and organics analyses use a quartz injector, while for HF analyses use an alumina injector. Hence simply interchange between quartz and alumina injectors for appropriate analyses. Several internal diameters for both quartz and alumina injectors are also available.

Fixed Quartz Torches (One Piece)



- Precise quartz construction
- Wide range held in stock
- Simple to use
- Lowest initial cost

RF Coils – more efficient energy transfer



Why Change your RF Coil?

- Regular replacement of corroded coils reduces the load on the RF generating system.
- Changing corroded coils increases energy transfer, resulting in a more robust plasma and generally higher analytical line intensities.

Advantages of Glass Expansion RF Coils

- High quality and consistent plating of our coils promotes extended coil life.
- Each coil is supplied on a plastic former ensuring correct dimensions and easier installation.
- Each coil is supplied in a special protective container to ensure correct dimensions are maintained, and the coil arrives corrosion free.
- Correct alignment of the RF Coil with respect to the torch body reduces devitrification of the outer tube.
- Reusable alignment tools ensure correct installation every time. Our Do-it-yourself instructions saves time.

Glass Expansion installation Kits for RF Coils

- Incorrect alignment of the torch in the coil will dramatically reduce torch life. The Glass Expansion Installation Kits help ensure correct alignment and maximum torch life.
- Correct alignment of the RF Coil with respect to the torch body reduces devitrification of the outer tube.
- Re-usable alignment tools are available separately to ensure correct installation of the coil every time.
- Our easy to follow Do-It-Yourself installation instructions save you time, and the cost of a service call.

All kits contain:

- An Installation Kit – Aligns coil to torch mounting bracket.
- Required Spanner/s – Designed specifically for each instrument.
- USB - Do-It-Yourself instructions.



ICP-MS Cones



Our ICP-MS interface cones are made from ultra-pure metals sourced from specialty smelters. Our highly experienced machinists use state of the art CNC machines and electron beam welding to provide cones with the finest tolerances for the highest quality.

We supply cones for all of the popular ICP-MS models and, to make sure you get all the support you need, we have a staff of technical experts and a fully equipped ICP-MS laboratory for testing and evaluation.

No-risk guarantee:

As with all of our products, our cones are backed by our complete satisfaction guarantee.

Free refurbishment:

Extend the life of your platinum cones with our free refurbishment program. In many cases, a platinum cone can be refurbished multiple times and its lifetime greatly extended. As a customer service, Glass Expansion will refurbish your platinum cones free-of-charge.

Platinum reclaim:

If your platinum cone cannot be refurbished, we will provide a rebate for the value of platinum in the cone.

Coneguard

The ConeGuard Thread Protector protects the cone thread from corrosive cleaning solutions and greatly extends cone life.

IsoMist XR Programmable Temperature Spray Chamber



The IsoMist XR programmable temperature controlled cyclonic spray chamber now features an improved thermodynamic design providing an extended temperature range and faster cool-down, so your ICP is ready to go sooner.

IsoMist XR is a compact, convenient and maintenance-free temperature controlled sample introduction system for all ICP's.

Improved Analytical Stability with Precise Temperature Control

On the IsoMist XR, the spray chamber temperature is accurately controlled through an improved thermodynamic design using a multi-stage peltier device. The spray chamber temperature is settable in 1°C increments from -25°C to 80°C guaranteeing optimum conditions can be used for any application.

Reduce Oxide Interferences in ICP-MS

Using the IsoMist XR spray chamber at sub-ambient temperatures on an ICP-MS, the sample is cooled, less water vapor is transferred to the plasma resulting in lower oxide formation and reduced polyatomic (ArO, ArOH) interferences. Less oxides in the plasma mean fewer interferences, improving accuracy and detection limits.

Perfect for Naphtha and Gasoline Analysis

For volatile solvents, a lower sample introduction temperature reduces nebulization efficiency avoiding quenching of the plasma from solvent overloading. With a minimum operating temperature of -25°C, analyzing volatile organic solvents such as naphtha and gasoline by ICP is even easier.

Improve Analytical Stability with Constant Spray Chamber Temperature

Fluctuations in the lab temperature affects sample viscosity and nebulization efficiency. Maintaining the sample introduction system at a constant and stable temperature improves analytical reproducibility, enhances throughput and lowers operating costs by reducing the need to re-run samples when a check standard drifts outside the acceptable upper or lower limits.

Elevated Sample Introduction Temperatures Enhances Sensitivity

The sensitivity for many analyses can be enhanced by operating the spray chamber at elevated temperatures - especially important for limited sample volumes. Heating the spray chamber also helps with the analysis of viscous samples such as lubricants and edible oils.

A Spray Chamber Optimized for Analytical Performance

The IsoMist XR incorporates a proven cyclonic spray chamber design in glass, quartz and HF resistant PFA with Helix CT interface. Compared to a Scott type spray chamber, cyclonic spray chambers are more sensitive and have better washout. The IsoMist XR includes the Helix CT nebulizer interface, which eliminates sample contamination and ensures easy nebulizer removal for routine nebulizer cleaning. The Helix CT nebulizer interface also has zero dead volume, reducing carry-over and improving washout between samples. With a positive stop built-in, Helix CT ensures correct and reproducible nebulizer insertion depth for constant nebulizer performance.



Easy to Use Software

For maximum convenience, the IsoMist XR can be controlled from a PC via USB or Bluetooth wireless interface. The spray chamber temperature can be monitored during an analytical run with time vs temperature plot on your PC screen.

Elegant, Ergonomic and Compact

The IsoMist XR is an elegant, compact, stand-alone system manufactured from materials resistant to attack from acids and solvents commonly used in ICP analysis. By using a peltier to maintain the spray chamber temperature, the messy, noisy and high-maintenance refrigerated circulating baths used with jacketed spray chambers has been eliminated. The compact design means all IsoMist XR Programmable Temperature Controlled Spray Chambers are compatible with virtually any ICP-OES or ICP-MS.

Guardian In-Line Sample Filter



If there are particulates in your samples, there is a risk that they may get trapped in the narrow bore sample tubing or within the nebulizer. The Guardian In-Line Sample Filter provides a simple and effective way to eliminate this risk. This filter is easily inserted in the sample tubing between the autosampler probe and the nebulizer. It incorporates a 120 micron PolyComb filter and is suitable for use with 1/16 inch (1.6mm) OD or 1.3mm OD sample tubing.

The purpose-built clog-resistant design is ideal for ICP samples. Unlike sintered or frit style filters, the linear honeycomb structure makes the PolyComb filter resistant to clogging from particulates. Any particle build-up is easily removed by back-flushing using the Eluo Adaptor 70-803-1160. And the PEEK material is suitable for use with all of the most common ICP solutions.



Eluo Adapter For In-Line Filter

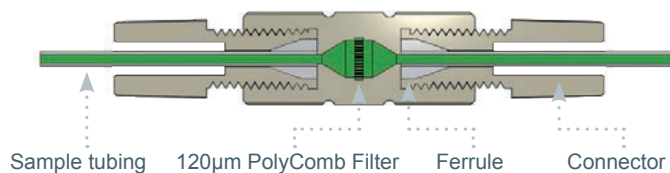

Guardian In-Line Sample Filter

In-Line Filter	70-803-1108
Eluo Adaptor for In-Line Filter	70-803-1160
Fitting Seal 1/16 (PKT 10)	70-803-0749
Fitting Seal 1.3mm (PKT 10)	70-803-0748

Guardian In-Line Non-Return Gas Filter



The new Guardian In-line Non-Return Gas Filter provides protection for your ICP system in two ways:

1. A non-return valve prevents acidified sample or rinse solution syphoning into the instrument gas box.
2. 30µm PolyComb filter protects the nebulizer from particulates in the instrument gas supply.

The Guardian In-line Non-Return Gas Filter is positioned between the Argon inlet on the Direct Connection nebulizer and the gas supply fitting on the instrument. The In-line Non-Return Filter has a one-way valve that allows argon to flow from the instrument into the nebulizer, but prevents liquid syphoning into the instrument. A unique PolyComb 30µm filter design protects the nebulizer from particulates from the gas supply or from worn or damaged fittings in the gas lines. Unlike Sintered or Frit style filters, the linear honeycomb structure makes PolyComb most resistant to particulate and dissolved solid clogging.

Syphoning of the sample or rinse solution into the nebulizer argon control module on your ICP can occur at the end of an analytical run when the nebulizer gas pressure is turned off and there is liquid in the sample flow path. It is made worse if the autosampler probe stays in the rinse position at the end of a run.

A real problem using an autosampler for unattended overnight runs, it is a silent, invisible killer of your ICP. Acidified solution in the instrument Argon control module can cause corrosion to electronic sensors in mass flow controllers and damage regulators that can result in expensive repairs to your ICP and un-planned down time.

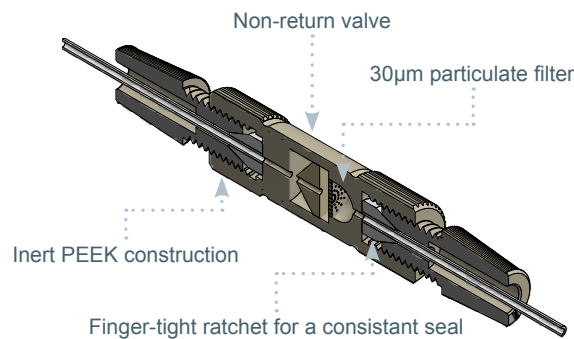

Guardian In-Line Non-Return Gas Filter

Guardian DC In-Line Non-Return Gas Filter	70-803-1942
Guardian In-Line Non-Return Gas Filter	70-803-1362

Eluo Nebulizer Cleaning Tool



Cleaning your nebulizer is as easy as 1, 2, 3.

1. Fill your Eluo with Methanol.
2. Insert your nebulizer, tip first, into the Eluo.
3. Clean your nebulizer by pressing the Plunger down.

Particle build-up in a nebulizer capillary and tip causes sample flow to be constricted, reducing nebulizer efficiency and performance. Now, blocked nebulizers can be safely and easily restored to optimum performance with a revolutionary cleaning instrument – the Eluo.

The Eluo is designed to efficiently deliver a cleanser through the nebulizer capillary to dislodge particle build-up and thoroughly clean the nebulizer. One simple action does it all. No more messy procedures or shattered nebulizers in ultrasonic baths. Use the Eluo regularly to maintain nebulizer performance and prolong nebulizer life. Every lab should have an Eluo.

The Eluo can also be conveniently used to clean the Inline Particle Filter P/N 70-803-1108 with the addition of Adaptor P/N 70-803-1160.

Eluo Nebulizer Cleaning Tool

Eluo for Glass concentric Nebulizers	70-ELUO
Eluo HF Nebulizer Cleaner	70-ELUO-OPD
Fluka RBS-25 concentrate	FLUKA25
O-ring Kit for Eluo (2 sets)	70-0806

Trident CT™ In-Line Reagent Additions Kits

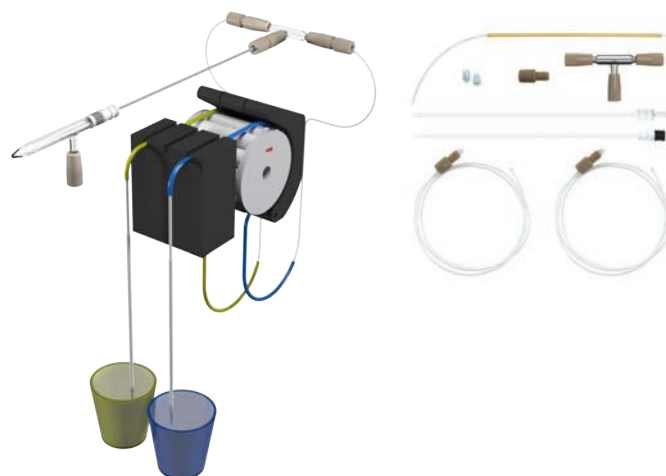

Internal standards are often used in ICP Spectrometry to improve stability. The internal standardization process involves the addition of a known concentration of a particular element to every sample and can be a very time-consuming procedure. The Glass Expansion Trident Kits allow the internal standard to be automatically mixed with each sample during sample introduction, saving considerable sample preparation time.

The Trident CT™ mixing chamber is based on the industry-proven design of the Trident, but with the addition of Glass Expansion's ConstantTorque™ (CT) to provide a simple-to-use, leak-free connection for both the internal standard and sample, every time.

The heart of the kit is the mixing chamber, designed with zero dead volume CT fittings. With other mixing chambers, worn or improperly fitted connections leak, inject a stream of air bubbles into the nebulizer flow, degrading short-term analytical precision (%RSD). By using CT ratchet-style fittings, the Trident CT eliminates air leaks, optimizing analytical performance.

The Trident CT features:

- Compact, efficient mixing chamber ensures complete mixing of the sample and reagent.
- CT fittings for a durable, leak-free seal on all connections.
- Zero dead volume connections.
- Completely modular so that damaged or lost components can easily be replaced.

Check the Trident Dilution Factor Calculator on our website to find out the sample and internal standard dilution factors for selected combinations of pump tubing.

The peristaltic pump tubing is not supplied as part of the Internal Standard Kit but can be ordered separately.

In-Line Reagent Additions Kits

Trident CT In-Line Reagent Additions Kit	60-703-1179
Trident Internal Standard Kit for HF (original design)	60-808-1150

Elegra Argon Humidifier



Elegra

Elegra Dual

An Argon Humidifier is commonly used in ICP analyses involving samples with high concentrations of dissolved solids. It helps to alleviate salt deposits in the nebulizer and torch injector, allowing uninterrupted and maintenance-free operation.

- Compact, cost-effective design.
- No heating or electric power required.
- Non-pressurized water reservoir.
- An easy-to-use bypass switch allows you to take the Elegra off-line without disconnecting argon lines. (Not available with Elegra Dual)
- Highly efficient membrane humidification technology.
- Improved signal stability for samples with high TDS.
- Simple to install, use and maintain.
- Improves productivity by reducing down-time for cleaning.
- Inert metal-free construction eliminates contamination.
- Maximum and minimum fill marks ensure that you are always operating under optimum conditions.
- Compatible with all ICP-OES and ICP-MS models. Direct connection to argon outlet provided for most models.
- Elegra Dual two-channel configuration available for ICP-MS instruments using auxiliary argon.

Elegra Argon Humidifier

O-ring for Capricorn or Elegra Cap (PKT 3)	70-V-225
Elegra Stand	70-803-1581

High Sensitivity Single-Cell Sample Introduction System for ICP-MS



Single-cell analysis using an Inductively Coupled Plasma-Mass Spectrometer (SC-ICP-MS) is enhancing the fundamental understanding in cellular biology, oncology and drug discovery. SC-ICP-MS provides for the quantification of metals in individual biological cells and is used as a research tool to allow scientists to study disease aetiology, better understand diseased cell states and develop new drug treatments to give better patient outcomes.

In single-cell analysis, the sample introduction system converts a continuous stream of biological cells efficiently into an aerosol of individual cells and transfers the aerosol into the Inductively Coupled Plasma of the ICP-MS for analysis. A critical aspect of the sample introduction system is the cells must remain intact and unruptured during the nebulization process to ensure each individual cell produces a single ion burst inside the plasma that can be transferred into the mass analyser of the ICP-MS for quantification.

Conventional ICP-MS spray chambers have low transport efficiencies (typically < 5% TE) that filter out larger droplets (> 5µm) from the nebulizer aerosol. As most cell lines of interest are larger than 5µm, the secondary filtering mechanism of conventional spray chamber designs rejects a high proportion of the cells from passing to the plasma. To overcome this significant deficiency the Glass Expansion spray chamber design for single cell analysis is different from conventional ICP-MS spray chambers.

Glass Expansion have developed a high sensitivity Single-Cell Sample Introduction system which consists of:

- High efficiency, low uptake, concentric glass nebulizer designed to efficiently nebulize single-cell suspensions without compromising cell integrity
- Low volume, on-axis, laminar-flow spray chamber directly coupled to the ICP for the highest transport efficiency of the nebulized single-cell
- Patent pending MicroJet gas adapter which entrains and shapes the aerosol plume to reduce cell deposition onto the spray chamber walls and increase sample transport efficiency suspension

Single-Cell Sample Introduction System

For Agilent® ICP-MS	KT-1155
For Thermo® ICP-MS	KT-1172
For TOFWERK icpTOF	KT-1172
For NexION 1000/2000/5000	KT-1184
For PerkinElmer® NexION 300/350	KT-1204
For NU ATTOM	KT-1205

Laser Ablation

P/N: 21-809-4309



P/N: 70-803-1600



P/N: 31-808-4034



P/N: 20-809-4550



P/N: 21-809-2801



P/N: 31-808-3863
OD: 4mm
ID: 2mm



S13 (13 mm) cup Adaptors

P/N: 31-800-1007
ID: 4mm



P/N: 21-809-4140

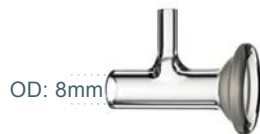

P/N: 21-809-0965C
OD: 6mm
ID: 4mm



P/N: 31-808-3045
OD: 4mm
ID: 2mm



GazFit Connectors



GazFit Union Connectors (for rigid walled tubing)

GazFit Union 4mm (PKT.2)	GAZ-04U
GazFit Union 6mm (PKT.2)	GAZ-06U
GazFit Union 8mm (PKT.2)	GAZ-08U



Standard GazFit Connectors (for soft walled tubing)

GazFit Connectors for 4mm OD side arm (PKT.4)	GAZ-04
GazFit Connectors for 5mm OD side arm (PKT.4)	GAZ-05
GazFit Connectors for 6mm OD side arm (PKT.4)	GAZ-06
GazFit Connectors for 8mm OD arm (PKT.2)	GAZ-08
GazFit Connectors, 2 for 6mm OD side arms, 2 for 4mm OD side arms (PKT.4)	GAZ-0604
GazFit Connectors for 6mm OD side arm with connection for 1/8inch ID tubing (PKT.4)	GAZ-06-1/8

Autosampler Probes



For Cetac 260, 280, 520, 520HS, 560, 860 and XLR8

PTFE Encapsulated Carbon Fibre Probe 0.25mm ID with EzyFit	70-803-1088
Polyimide sheathed Autosampler Probe 0.5mm ID	60-808-1186L
PTFE Encapsulated Carbon Fibre Probe 0.25mm ID	70-803-1523
PTFE Encapsulated Carbon Fibre Probe 0.5mm ID	70-803-0784
PTFE Encapsulated Carbon Fibre Probe 0.5mm ID with UniFit	70-803-1380
PTFE Encapsulated Carbon Fibre Probe 0.75mm ID with ratchet fitting	70-803-1443
PTFE Encapsulated Carbon Fibre Probe 0.75mm ID	70-803-1880
PTFE Encapsulated Carbon Fibre Probe 1.0mm ID with ratchet fitting	70-803-0793
PTFE Encapsulated Carbon Fibre Probe 1.0mm ID	70-803-1879

For Cetac ASX 110

PFA sheathed Autosampler Probe 0.25mm ID with EzyFit	70-803-1072
PFA sheathed Autosampler Probe 0.25mm ID with UniFit	70-803-1073
PTFE Sheathed Carbon Fibre Probe 0.18mm ID with UniFit	70-803-1684
PTFE Encapsulated Carbon Fibre Probe 0.3mm ID with UniFit	70-803-1191
PTFE Encapsulated Carbon Fibre Probe 1.0mm ID	70-803-1182

For Agilent® SPS 3/SPS 4

PTFE Encapsulated Carbon Fibre Probe 0.25mm ID	70-803-0910
PTFE Encapsulated Carbon Fibre Probe 0.50mm ID	70-803-0909
PTFE Encapsulated Carbon Fibre Probe 0.75mm ID	70-803-0908
PTFE Encapsulated Carbon Fibre Probe 1.0mm ID	70-803-0853

For Agilent® I-AS

PTFE Encapsulated Carbon Fibre Probe 0.25mm ID with UniFit, 1100mm total length	60-703-1010
PTFE Encapsulated Carbon Fibre Probe 0.3mm ID with UniFit, 686 mm total length	60-703-1009
PTFE Encapsulated Carbon Fibre Probe 1.0mm ID	60-703-0533

For PerkinElmer® S10 or AS93+

PTFE Encapsulated Carbon Fibre Probe 0.25mm ID	70-803-1071
PTFE Encapsulated Carbon Fibre Probe 0.5mm ID with UniFit	70-803-0991
PTFE Encapsulated Carbon Fibre Probe 0.5mm ID	70-803-1440
PTFE Encapsulated Carbon Fibre Probe 1.0mm ID	70-803-0816

For Shimadzu®

PTFE Encapsulated Carbon Fibre Probe 0.3mm ID with UniFit, for Shimadzu® ASC-6100F/9800	70-803-1200
PTFE Coated Viton O-rings (PKT 10) With UniFit, for Shimadzu® AS10	70-803-1477

Glass DC Nebulizers

SeaSpray

400µL/min uptake A13-1-USS04X

MicroMist

400µL/min uptake A13-1-UM04X
 200µL/min uptake A13-1-UM02X
 100µL/min uptake A13-1-UM01Q
 50µL/min uptake A13-1-UM005Q



Conikal

1mL/min uptake A13-1-UC1X

Quartz DC Nebulizers

SeaSpray

1mL/min uptake A13-1-QSS1



DC Nebulizers for HF

OpalMist

400µL/min uptake A13-1-PFA04X
 200µL/min uptake A13-1-PFA02X
 100µL/min uptake A13-1-PFA01Q
 50µL/min uptake A13-1-PFA005Q



Peltier Controlled Cyclonic Spray Chambers

Glass Spray Chamber KT-1116
 Quartz Spray Chamber KT-1116Q
 PFA Spray Chamber KT-1116P



Spray Chambers

Single-Cell Spray Chamber Kit

High Sensitivity Single-Cell Sample Introduction System KT-1155



HydraMist Simultaneous Cold Vapor/Pneumatic Nebulization Spray Chamber

Hydride Kit KT-1168



Spray Chambers

(continued)

*Twister

50mL Cyclonic with Aux. 20-809-2574HE



*Cinnabar

20mL Cyclonic with Aux. 20-809-2575HE

Quartz Scott Style

For 7900 UHMI 20-809-4144



Spray Chambers for HF

*Tracey PFA44

44ml Cyclonic with Aux. 20-809-2578
 Spray Chamber Adaptor KT-1104



*Requires adaptor KT-1104.

Torches

Quartz Torches

with 1.0mm Injector 30-807-0558
 with 1.5mm Injector 30-807-0557
 with 2.0mm Injector 30-807-3608
 with 2.5mm Injector 30-807-0556

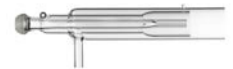

Torch Options

Quartz Torch Bonnet 31-808-2577
 Quartz Connector with Dilution Port 31-808-3217
 Quartz Connector with 45deg Dilution Port 31-808-3280
 Straight Quartz Connector 31-808-3288
 Clamp (PKT 2) 70-803-0846



Torches

(continued)

Semi-Demountable Torch

with 2.4mm Quartz Injector 30-808-3853



Torch Options

2.4mm Tapered Quartz Injector 31-808-4168



2.4mm Tapered Alumina Injector 31-808-3855



2.4mm Sapphire Capillary Injector 31-808-4159



RF Coils

Copper 70-900-7800C



Silver 70-900-7800S



Gold 70-900-7800G



RF Coil Installation Kit 70-900-7500T



Cones

Sampler Cones

Nickel Sampler AT7701-Ni



Nickel Sampler with Nickel plated base AT7701-Ni/Ni



Cones

(continued)

Sampler Cones (continued)

Aluminium Sampler AT7701-Al



Platinum Sampler AT7706-Pt

Platinum Sampler (18 mm Insert) AT7706A-Pt

Platinum Sampler Boron Free AT7706-Pt-BF

Platinum Sampler with Nickel plated base AT7706-Pt/NiP



Platinum Sampler (15mm insert) with Nickel base AT7706B-Pt/Ni

Platinum Sampler with Nickel plated base (Extended Life) AT7706L-Pt/NiP

Skimmer Cones

Nickel Skimmer for x-lens AT7902X-Ni



Aluminium Skimmer for x-lens AT7902X-Al



Platinum Skimmer for x-lens AT7908X-Pt



Platinum Skimmer with Nickel base for x-lens AT7908X-Pt/Ni



Nickel Skimmer for s-lens AT7702S-Ni

Copper Skimmer AT7702S-Cu

Platinum Skimmer for s-lens AT7708S-Pt

Platinum Skimmer with Nickel base for s-lens AT7708S-Pt/Ni

Cones

(continued)

Cone Options

Skimmer Cone Guard	70-803-1004
Graphite Gasket (PKT 3)	AT7703
Long Life Shield Plate	AT5004



Common Accessories

Elegra Argon Humidifier

Elegra Dual Two-channel Argon Humidifier	70-803-1273
--	-------------



Elegra Stand	70-803-1581
--------------	-------------



Guardian In-Line Filters

Guardian DC in-line non-return gas filter	70-803-1942
Guardian in-line sample filter	70-803-1108



Trident Internal Standard Kits

Trident CT Standard Kit	60-703-1179
Standard Kit for HF	60-808-1150



Autosampler Probes

(See page 14 for complete list of probes)

For Agilent® I-AS

PTFE Encapsulated Carbon Fibre Probe	60-703-1010
0.25mm ID	
PTFE Encapsulated Carbon Fibre Probe	60-703-1009
0.3mm ID	

For Cetac ASX-520

Polyimide sheathed Autosampler Probe	60-808-1186L
0.5mm ID	
PTFE Encapsulated Carbon Fibre Probe	70-803-0784
0.5mm ID	
PTFE Encapsulated Carbon Fibre Probe	70-803-1443
0.75mm ID	
PTFE Encapsulated Carbon Fibre Probe	70-803-0793
1.0mm ID	



For SPS 3/SPS 4

PTFE Encapsulated Carbon Fibre Probe	70-803-0908
0.75mm ID	
PTFE Encapsulated Carbon Fibre Probe	70-803-0853
1.0mm ID	

Glass DC Nebulizers

SeaSpray

400µL/min uptake A13-1-USS04X

MicroMist

400µL/min uptake A13-1-UM04X
 200µL/min uptake A13-1-UM02X
 100µL/min uptake A13-1-UM01Q
 50µL/min uptake A13-1-UM005Q



Conikal

1mL/min uptake A13-1-UC1X

Quartz DC Nebulizers

SeaSpray

1mL/min uptake A13-1-QSS1



DC Nebulizers for HF

OpalMist

400µL/min uptake A13-1-PFA04X
 200µL/min uptake A13-1-PFA02X
 100µL/min uptake A13-1-PFA01Q
 50µL/min uptake A13-1-PFA005Q



Peltier Controlled Cyclonic Spray Chambers

Glass Spray Chamber KT-1116
 Quartz Spray Chamber KT-1116Q
 PFA Spray Chamber KT-1116P



Spray Chambers

Single-Cell Spray Chamber Kit

High Sensitivity Single-Cell Sample Introduction System KT-1155



HydraMist Simultaneous Cold Vapor/Pneumatic Nebulization Spray Chamber

Hydride Kit KT-1168



Spray Chambers

***Twister**

50mL Cyclonic with Aux. 20-809-2574HE



***Cinnabar**

20mL Cyclonic with Aux. 20-809-2575HE

Quartz Scott Style

For 7900 UHMI 20-809-4144



Spray Chambers for HF

***Tracey PFA44**

44ml Cyclonic with Aux. 20-809-2578
 Spray Chamber Adaptor KT-1104



*Requires adaptor KT-1104.

Torches

Quartz Torches

with 1.0mm Injector 30-807-0558
 with 1.5mm Injector 30-807-0557
 with 2.0mm Injector 30-807-3608
 with 2.5mm Injector 30-807-0556



Torch Options

Quartz Torch Bonnet 31-808-2577
 Quartz Connector with Dilution Port 31-808-3217
 Quartz Connector with 45deg Dilution Port 31-808-3280
 Straight Quartz Connector 31-808-3288
 Clamp (PKT 2) 70-803-0846



Torches

(continued)

Semi-Demountable Torch

with 2.4mm Quartz Injector 30-808-3853



Torch Options

2.4mm Tapered Quartz Injector 31-808-4168



2.4mm Tapered Alumina Injector 31-808-3855



2.4mm Sapphire Capillary Injector 31-808-4159



RF Coils

Copper 70-900-7800C



Silver 70-900-7800S



Gold 70-900-7800G



RF Coil Installation Kit 70-900-7500T



Cones

Sampler Cones

Nickel Sampler AT7701-Ni

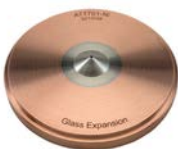

Nickel Sampler with Nickel plated base AT7701-Ni/Ni



Cones

(continued)

Sampler Cones (continued)

Aluminium Sampler AT7701-Al



Platinum Sampler AT7706-Pt

Platinum Sampler (18 mm Insert) AT7706A-Pt

Platinum Sampler Boron Free AT7706-Pt-BF

Platinum Sampler with Nickel plated base AT7706-Pt/NiP



Platinum Sampler (15mm insert) with Nickel base AT7706B-Pt/Ni

Platinum Sampler with Nickel plated base (Extended Life) AT7706L-Pt/NiP

Skimmer Cones

Nickel Skimmer for x-lens AT7902X-Ni



Aluminium Skimmer for x-lens AT7902X-Al



Platinum Skimmer for x-lens AT7908X-Pt



Platinum Skimmer with Nickel base for x-lens AT7908X-Pt/Ni



Nickel Skimmer for s-lens AT8902S-Ni

Copper Skimmer for s-lens AT8902S-Cu

Platinum Skimmer for s-lens AT8908S-Pt/Cu

Platinum Skimmer with Nickel base for s-lens AT8908M-Pt/Ni

Platinum Skimmer with Nickel base for m-lens AT8908M-Pt/Ni

Cones

(continued)

Cone Options

Skimmer Cone Guard	70-803-1004
Graphite Gasket (PKT 3)	AT7703
Long Life Shield Plate	AT5004



Common Accessories

Elegra Argon Humidifier

Elegra Dual Two-channel Argon Humidifier	70-803-1273
--	-------------



Elegra Stand	70-803-1581
--------------	-------------



Guardian In-Line Filters

Guardian DC in-line non-return gas filter	70-803-1942
Guardian in-line sample filter	70-803-1108



Trident Internal Standard Kits

Trident CT Standard Kit	60-703-1179
Standard Kit for HF	60-808-1150



Autosampler Probes

(See page 14 for complete list of probes)

For Agilent® I-AS

PTFE Encapsulated Carbon Fibre Probe	60-703-1010
0.25mm ID	
PTFE Encapsulated Carbon Fibre Probe	60-703-1009
0.3mm ID	

For Cetac ASX-520

Polyimide sheathed Autosampler Probe	60-808-1186L
0.5mm ID	
PTFE Encapsulated Carbon Fibre Probe	70-803-0784
0.5mm ID	
PTFE Encapsulated Carbon Fibre Probe	70-803-1443
0.75mm ID	
PTFE Encapsulated Carbon Fibre Probe	70-803-0793
1.0mm ID	



For SPS 3/SPS 4

PTFE Encapsulated Carbon Fibre Probe	70-803-0908
0.75mm ID	
PTFE Encapsulated Carbon Fibre Probe	70-803-0853
1.0mm ID	

Glass DC Nebulizers

SeaSpray

400µL/min uptake A13-1-USS04X

MicroMist

400µL/min uptake A13-1-UM04X

200µL/min uptake A13-1-UM02X

100µL/min uptake A13-1-UM01Q

50µL/min uptake A13-1-UM005Q



Conikal

1mL/min uptake A13-1-UC1X

Quartz DC Nebulizers

SeaSpray

1mL/min uptake A13-1-QSS1



DC Nebulizers for HF

OpalMist

400µL/min uptake A13-1-PFA04X

200µL/min uptake A13-1-PFA02X

100µL/min uptake A13-1-PFA01Q

50µL/min uptake A13-1-PFA005Q



Peltier Controlled Cyclonic Spray Chambers

Glass Spray Chamber KT-1116

Quartz Spray Chamber KT-1116Q

PFA Spray Chamber KT-1116P



Spray Chambers

Single-Cell Spray Chamber Kit

High Sensitivity Single-Cell Sample Introduction System KT-1155



HydraMist Simultaneous Cold Vapor/ Pneumatic Nebulization Spray Chamber

Hydride Kit KT-1168



Spray Chambers

*Twister

20mL Cyclonic with Aux. 20-809-2574HE

*Cinnabar

20mL Cyclonic with Aux. 20-809-2575HE



Spray Chambers for HF

*Tracey PFA44

44ml Cyclonic with Aux. 20-809-2578

Spray Chamber Adaptor KT-1104



*Requires adaptor KT-1104.

Torches

Quartz Torches

with 1.0mm Injector 30-807-0558

with 1.5mm Injector 30-807-0557

with 2.0mm Injector 30-807-3608

with 2.5mm Injector 30-807-0556

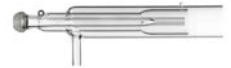

Torch Options

Quartz Torch Bonnet 31-808-2577

Quartz Connector with Dilution Port 31-808-3217

Quartz Connector with 45deg Dilution Port 31-808-3280

Straight Quartz Connector 31-808-3288

Clamp (PKT 2) 70-803-0846



Semi-Demountable Torch

with 2.4mm Quartz Injector 30-808-3853



Torch Options





2.4mm Tapered Quartz Injector 31-808-4168

2.4mm Tapered Alumina Injector 31-808-3855

2.4mm Sapphire Capillary Injector 31-808-4159





RF Coils

Copper	70-900-7800C	
Silver	70-900-7800S	
Gold	70-900-7800G	
RF Coil Installation Kit	70-900-7500T	

Cones

Sampler Cones

Nickel Sampler	AT7701-Ni	
Nickel Sampler with Nickel plated base	AT7701-Ni/Ni	
Aluminium Sampler	AT7701-Al	
Platinum Sampler	AT7706-Pt	
Platinum Sampler (18 mm Insert)	AT7706A-Pt	
Platinum Sampler Boron Free	AT7706-Pt-BF	

Cones

(continued)

Sampler Cones (continued)

Platinum Sampler with Nickel plated base	AT7706-Pt/NiP	
Platinum Sampler with solid Nickel base	AT7706-Pt/Ni	
Platinum Sampler (15mm insert) with Nickel base	AT7706B-Pt/Ni	
Platinum Sampler with Nickel plated base (Extended Life)	AT7706L-Pt/NiP	

Skimmer Cones

Nickel Skimmer for x-lens	AT7702X-Ni	
Aluminium Skimmer for x-lens	AT7702X-Al	
Platinum Skimmer for x-lens	AT7708X-Pt	

Platinum Skimmer with Nickel base for x-lens	AT7708X-Pt/Ni
Platinum Skimmer with Boron Free for x-lens	AT7708X-Pt-BF

Cone Options

Skimmer Cone Guard	70-803-1008	
Graphite Gasket (PKT 3)	AT7703	
Long Life Shield Plate	AT5004	

Common Accessories

Elegra Argon Humidifier

Elegra Dual Two-channel Argon Humidifier 70-803-1273



Elegra Stand 70-803-1581



Guardian In-Line Filters

Guardian DC in-line non-return gas filter 70-803-1942
 Guardian in-line sample filter 70-803-1108



Trident Internal Standard Kits

Trident CT Standard Kit 60-703-1179
 Standard Kit for HF 60-808-1150



Autosampler Probes

(See page 14 for complete list of probes)

For Agilent® I-AS

PTFE Encapsulated Carbon Fibre Probe
 0.25mm ID 60-703-1010
 PTFE Encapsulated Carbon Fibre Probe
 0.3mm ID 60-703-1009

For Cetac ASX-520

Polyimide sheathed Autosampler Probe
 0.5mm ID 60-808-1186L
 PTFE Encapsulated Carbon Fibre Probe
 0.5mm ID 70-803-0784
 PTFE Encapsulated Carbon Fibre Probe
 0.75mm ID 70-803-1443
 PTFE Encapsulated Carbon Fibre Probe
 1.0mm ID 70-803-0793



For SPS 3/SPS 4

PTFE Encapsulated Carbon Fibre Probe
 0.75mm ID 70-803-0908
 PTFE Encapsulated Carbon Fibre Probe
 1.0mm ID 70-803-0853

Glass DC Nebulizers

SeaSpray

400µL/min uptake A13-1-USS04X

MicroMist

400µL/min uptake A13-1-UM04X
 200µL/min uptake A13-1-UM02X
 100µL/min uptake A13-1-UM01Q
 50µL/min uptake A13-1-UM005Q

Conikal

1mL/min uptake A13-1-UC1X



Spray Chambers

*Twister

50mL Cyclonic with Aux. 20-809-2574HE

*Cinnabar

20mL Cyclonic with Aux. 20-809-2575HE



Quartz DC Nebulizers

SeaSpray

1mL/min uptake A13-1-QSS1



DC Nebulizers for HF

OpalMist

400µL/min uptake A13-1-PFA04X
 200µL/min uptake A13-1-PFA02X
 100µL/min uptake A13-1-PFA01Q
 50µL/min uptake A13-1-PFA005Q



Peltier Controlled Cyclonic Spray Chambers

Glass Spray Chamber KT-1116
 Quartz Spray Chamber KT-1116Q
 PFA Spray Chamber KT-1116P



Spray Chambers

Single-Cell Spray Chamber Kit

High Sensitivity Single-Cell Sample Introduction System KT-1155



HydraMist Simultaneous Cold Vapor/ Pneumatic Nebulization Spray Chamber

Hydride Kit KT-1168



Spray Chambers for HF

*Tracey PFA44

44ml Cyclonic with Aux. 20-809-2578
 Spray Chamber Adaptor KT-1104

*Requires adaptor KT-1104.



Torches

Quartz Torches

with 1.0mm Injector 30-807-0558
 with 1.5mm Injector 30-807-0557
 with 2.0mm Injector 30-807-3608
 with 2.5mm Injector 30-807-0556



Torch Options

Quartz Torch Bonnet 31-808-2577
 Quartz Connector with Dilution Port 31-808-3217
 Quartz Connector with 45deg Dilution Port 31-808-3280
 Straight Quartz Connector 31-808-3288
 Clamp (PKT 2) 70-803-0846



Semi-Demountable Torch

with 2.4mm Quartz Injector 30-808-3853







Torch Options

2.4mm Tapered Quartz Injector 31-808-4168
 2.4mm Tapered Alumina Injector 31-808-3855
 2.4mm Sapphire Capillary Injector 31-808-4159



RF Coils

Copper	70-900-7700C	
Silver	70-900-7700S	
Gold	70-900-7700G	
RF Coil Installation Kit	70-900-7500T	

Cones

Sampler Cones

Nickel Sampler	AT7701-Ni	
Nickel Sampler with Nickel plated base	AT7701-Ni/Ni	
Aluminium Sampler	AT7701-Al	
Platinum Sampler	AT7706-Pt	
Platinum Sampler (18 mm Insert)	AT7706A-Pt	
Platinum Sampler Boron Free	AT7706-Pt-BF	
Platinum Sampler with Nickel plated base	AT7706-Pt/NiP	

Cones

(continued)

Sampler Cones (continued)

Platinum Sampler with solid Nickel base	AT7706-Pt/Ni
Platinum Sampler (15mm insert) with Nickel base	AT7706B-Pt/Ni
Platinum Sampler with Nickel plated base (Extended Life)	AT7706L-Pt/NiP

Skimmer Cones

Nickel Skimmer for x-lens	AT7702X-Ni
Aluminium Skimmer for x-lens	AT7702X-Al

Platinum Skimmer for x-lens	AT7708X-Pt
-----------------------------	------------

Platinum Skimmer with Nickel base for x-lens	AT7708X-Pt/Ni
--	---------------

Platinum Skimmer with Boron Free for x-lens	AT7708X-Pt-BF
---	---------------

Nickel Skimmer for s-lens	AT7702S-Ni
---------------------------	------------

Platinum Skimmer for s-lens	AT7708S-Pt
-----------------------------	------------

Platinum Skimmer with Nickel base for s-lens	AT7708S-Pt/Ni
--	---------------

Cone Options

Skimmer Cone Guard for x-lens	70-803-1008
Skimmer Cone Guard for s-lens	70-803-1004
Retaining Ring	AT7704
Graphite Gasket (PKT 3)	AT7703
Long Life Shield Plate	AT5004



Common Accessories

Elegra Argon Humidifier

Elegra Dual Two-channel Argon Humidifier 70-803-1273



Elegra Stand 70-803-1581



Guardian In-Line Filters

Guardian DC in-line non-return gas filter 70-803-1942
 Guardian in-line sample filter 70-803-1108



Trident Internal Standard Kits

Trident CT Standard Kit 60-703-1179
 Standard Kit for HF 60-808-1150



Autosampler Probes

(See page 14 for complete list of probes)

For Agilent® I-AS

PTFE Encapsulated Carbon Fibre Probe 0.25mm ID 60-703-1010

PTFE Encapsulated Carbon Fibre Probe 0.3mm ID 60-703-1009

For Cetac ASX-520

Polyimide sheathed Autosampler Probe 0.5mm ID 60-808-1186L

PTFE Encapsulated Carbon Fibre Probe 0.5mm ID 70-803-0784

PTFE Encapsulated Carbon Fibre Probe 0.75mm ID 70-803-1443

PTFE Encapsulated Carbon Fibre Probe 1.0mm ID 70-803-0793



For SPS 3/SPS 4

PTFE Encapsulated Carbon Fibre Probe 0.75mm ID 70-803-0908

PTFE Encapsulated Carbon Fibre Probe 1.0mm ID 70-803-0853

Glass DC Nebulizers

SeaSpray

2mL/min uptake A13-07-USS2
 400µL/min uptake A13-07-USS04

MicroMist

400µL/min uptake A13-07-UM04
 200µL/min uptake A13-07-UM02

Conikal

2mL/min uptake A13-07-UC2
 1mL/min uptake A13-07-UC1

Slurry

4mL/min uptake A13-07-US6



Spray Chambers

Twister

50mL Cyclonic 20-809-9199HE



Tracey

50mL Cyclonic 20-808-8882HE



HydraMist Simultaneous Cold Vapor/ Pneumatic Nebulization Spray Chamber

Hydride Kit KT-1157



DC Nebulizers for HF

DuraMist

1mL/min uptake A13-07-DM1
 400µL/min uptake A13-07-DM04



OpalMist

2mL/min uptake A13-07-PFA2
 600µL/min uptake A13-07-PFA06
 200µL/min uptake A13-07-PFA02
 100µL/min uptake A13-07-PFA01
 50µL/min uptake A13-07-PFA005



VeeSpray

0.6 - 3mL/min uptake A13-07-CV6



Spray Chambers for HF

Twister TFE Spray Chamber

50mL Cyclonic 20-809-3452



Tracey TFE Spray Chamber

50mL Cyclonic 20-809-2507



IsoMist XR

Programmable Temperature Cyclonic Spray Chamber

Glass Spray Chamber KT-1137-XR
 Quartz Spray Chamber KT-1137Q-XR
 PFA Spray Chamber KT-1137P-XR



Torches

D-Torch

SVDV/VDV 30-808-3560

Comprises:

Base and Inner Tube 31-808-3568
 Quartz Outer Tube 31-808-3570
 Retaining Ring 31-808-3566
 Injector Ferrule 31-808-2962
 Injector Adaptor 31-808-3578



RV 30-808-3590

Comprises:

Base and Inner Tube 31-808-3568
 Quartz Outer Tube 31-808-3582
 Retaining Ring 31-808-3566
 Injector Ferrule 31-808-2962
 Injector Adaptor 31-808-3578

D-Torch Options:

Ceramic Outer Tube for SVDV/VDV 31-808-3580
 Ceramic Outer Tube for RV 31-808-3586
 Quartz Outer Tube for SVDV/VDV 31-808-3570
 Quartz Outer Tube for RV 31-808-3582
 O-ring Kit 70-803-1500
 Ignition Enhancer 31-808-4020



Quartz Torch

SVDV/VDV 31-808-3557

RV 31-808-3556



Tapered Injectors

Quartz Injector 0.8mm 31-808-3738
 Quartz Injector 1.4mm 31-808-3583
 Quartz Injector 1.8mm 31-808-3576
 Quartz Injector 2.4mm 31-808-3584
 Alumina Injector 1.5mm 31-808-3727
 Alumina Injector 1.8mm 31-808-3585
 Alumina Injector 2.4mm 31-808-3722



RF Coils

Silver 70-900-5100S

Gold 70-900-5100G

RF Coil Installation Kit 70-803-1415



Common Accessories

Elegra Argon Humidifier

Elegra Argon Humidifier 70-803-1268



Guardian In-Line Filters

Guardian DC in-line non-return gas filter 70-803-1942

Guardian in-line sample filter 70-803-1108



Trident Internal Standard Kits

Trident CT Standard Kit 60-703-1179

Standard Kit for HF 60-808-1150



Autosampler Probes

(See page 14 for complete list of probes)

For Cetac ASX-520

Polyimide sheathed Autosampler Probe 0.5mm ID 60-808-1186L

PTFE Encapsulated Carbon Fibre Probe 0.5mm ID 70-803-0784

PTFE Encapsulated Carbon Fibre Probe 0.75mm ID 70-803-1443

PTFE Encapsulated Carbon Fibre Probe 1.0mm ID 70-803-0793



For SPS 3/SPS 4

PTFE Encapsulated Carbon Fibre Probe 0.75mm ID 70-803-0908

PTFE Encapsulated Carbon Fibre Probe 1.0mm ID 70-803-0853

Glass DC Nebulizers

SeaSpray

2mL/min uptake A11-07-USS2
 400µL/min uptake A11-07-USS04

MicroMist

400µL/min uptake A11-07-UM04
 200µL/min uptake A11-07-UM02

Conikal

2mL/min uptake A11-07-UC2
 1mL/min uptake A11-07-UC1

Slurry

4mL/min uptake A11-07-US6



Spray Chambers

Tracey

50mL Cyclonic 20-809-0600HE



Twister

50mL Cyclonic 20-809-0285HE



Cinnabar

20mL Cyclonic 20-809-0183HE



Twinnabar

20mL Cyclonic 20-809-0448HE



DC Nebulizers for HF

DuraMist

1mL/min uptake A11-07-DM1
 400µL/min uptake A11-07-DM04



OpalMist

2mL/min uptake A11-07-PFA2
 600µL/min uptake A11-07-PFA06
 200µL/min uptake A11-07-PFA02
 100µL/min uptake A11-07-PFA01
 50µL/min uptake A11-07-PFA005



VeeSpray

0.6 - 3mL/min uptake A11-07-CV6



IsoMist XR

Programmable Temperature Cyclonic Spray Chamber

Glass Spray Chamber KT-1014-XR
 PFA Spray Chamber KT-1014P-XR
 All Glass System KT-1054-XR



Spray Chambers for HF

Tracey TFE

50mL Cyclonic 20-809-9188



Mounting Bracket for HF Spray Chamber

21-100-0364



PuraFlex Transfer Tube 21-809-2831

Connects spray chamber to torch. Requires adjustable mount 21-100-0215, or for HF, 21-100-0364.



Torches

D-Torch 30-808-2919

Comprises:

Base and Inner Tube	31-808-2918
Quartz Outer Tube	31-808-2685
Retaining Ring for Outer Tube	31-808-2818
Retaining Ring for Injector	31-808-2921



D-Torch Options:

Ceramic Outer Tube	31-808-3027
PuraFlex Transfer Tube with bend	21-809-3707



Tapered Injectors for D-Torch

Quartz Injector 0.8mm	31-808-3364
Quartz Injector 1.5mm	31-808-3591
Quartz Injector 1.8mm	31-808-3640
Quartz Injector 2.4mm	31-808-3043
Quartz Injector 2.4mm with Ball Joint	31-808-3110



Alumina Injectors for D-Torch

Alumina Injector 1.8mm	31-808-3325
Alumina Injector 2.4mm	31-808-3133



Sapphire Injectors for D-Torch

Sapphire Injector 2.0mm	31-808-3355
-------------------------	-------------



Fixed Torches

Quartz Torch with 90° Bend and 2.3mm Injector	30-808-0478
Quartz Torch (High Solids, short) with 90° Bend and 2.3mm Injector	30-808-9983
Quartz Torch (High Solids, Full-Length) with 90° Bend and 2.3mm Injector	30-807-0528
Quartz Torch with 90° Bend and 1.8mm Injector	30-808-3315
Quartz Torch with 90° Bend and 0.8mm Injector	30-808-1346



Fixed Torches for All Glass System

Quartz Torch with 2.3mm Injector and Right Angle Ball Joint	30-808-0540
Quartz Torch with 1.8mm Capillary Injector - (for oil analysis) and Right Angle Ball Joint	30-808-0887
Quartz Torch (High Solids) with 2.3mm Injector and Right Angle Ball Joint	30-808-1255
Quartz Torch (organics) with 0.8mm Injector and Right Angle Ball Joint	30-808-8216



Torches

(continued)

Semi Demountable Torch with Quartz Injector 30-808-0379

Comprises:

Quartz Torch Body	31-808-0353
Tapered Quartz Injector 2.4mm	31-808-0400
Torch Adaptor	31-808-0863
GazFit Connectors (PKT 4) - for 6mm OD side arms	GAZ-06
GazFit Connectors (PKT 2) - for 8mm torch adaptor	GAZ-08



Semi Demountable Torch with Alumina Injector 30-808-0383

Comprises:

Quartz Torch Body	31-808-0353
Tapered Alumina Injector 2.4mm	31-808-0401
Torch Adaptor	31-808-0863
GazFit Connectors (PKT 4) - for 6mm OD side arms	GAZ-06
GazFit Connectors (PKT 2) - for 8mm torch adaptor	GAZ-08



Semi Demountable Torch Options

Quartz Torch Body - Short (for high solids)	31-808-0177
---	-------------

Tapered Injectors for Semi Demountable Torch

Quartz Injector 1.0mm	31-808-0544
Quartz Injector 1.5mm	31-808-0543
Quartz Injector 1.8mm	31-808-0545
Quartz Injector 2.4mm	31-808-0400
Alumina Injector 1.8mm	31-808-0814
Alumina Injector 2.4mm	31-808-0401



Sapphire Injectors for Semi Demountable Torch

Sapphire Injector 2.4mm	31-808-1426
-------------------------	-------------

RF Coils

RF Coils for Vista Axial

Gold 70-900-1000G



Silver 70-900-1000S



Silver, Teflon Coated 70-900-1000ST

Installation kit 70-900-1000T



RF Coils for 700ES Axial

Gold 70-900-1004G



Silver 70-900-1004S



Silver, Teflon Coated 70-900-1004ST

Installation kit 70-900-1004T



Common Accessories

Elegra Argon Humidifier

Elegra Argon Humidifier 70-803-1265



Guardian In-Line Filters

Guardian DC in-line non-return gas filter 70-803-1942

Guardian in-line sample filter 70-803-1108



Trident Internal Standard Kits

Trident CT Standard Kit 60-703-1179

Standard Kit for HF 60-808-1150



Autosampler Probes

(See page 14 for complete list of probes)

For Cetac ASX-520

Polyimide sheathed Autosampler Probe
0.5mm ID 60-808-1186L

PTFE Encapsulated Carbon Fibre Probe
0.5mm ID 70-803-0784

PTFE Encapsulated Carbon Fibre Probe
0.75mm ID 70-803-1443

PTFE Encapsulated Carbon Fibre Probe
1.0mm ID 70-803-0793

For SPS 3/SPS 4

PTFE Encapsulated Carbon Fibre Probe
0.75mm ID 70-803-0908

PTFE Encapsulated Carbon Fibre Probe
1.0mm ID 70-803-0853



Glass DC Nebulizers

SeaSpray

2mL/min uptake	A11-07-USS2
400µL/min uptake	A11-07-USS04

MicroMist

400µL/min uptake	A11-07-UM04
200µL/min uptake	A11-07-UM02

Conikal

2mL/min uptake	A11-07-UC2
1mL/min uptake	A11-07-UC1

Slurry

4mL/min uptake	A11-07-US6
----------------	------------



DC Nebulizers for HF

DuraMist

1mL/min uptake	A11-07-DM1
400µL/min uptake	A11-07-DM04



OpalMist

2mL/min uptake	A11-07-PFA2
600µL/min uptake	A11-07-PFA06
200µL/min uptake	A11-07-PFA02
100µL/min uptake	A11-07-PFA01
50µL/min uptake	A11-07-PFA005



VeeSpray

0.6 - 3mL/min uptake	A11-07-CV6
----------------------	------------



IsoMist

Programmable Temperature Cyclonic Spray Chamber

Quartz Spray Chamber	KT-1022-XR
PFA Spray Chamber	KT-1022P-XR
All Glass System	KT-1055-XR



Spray Chambers

Tracey

50mL Cyclonic	20-809-0600HE
---------------	---------------



Twister

50mL Cyclonic	20-809-0285HE
---------------	---------------



Cinnabar

20mL Cyclonic	20-809-0183HE
---------------	---------------



Twinnabar

20mL Cyclonic	20-809-0448HE
---------------	---------------



Spray Chambers for HF

Tracey TFE

50mL Cyclonic	20-809-9188
---------------	-------------



Mounting Bracket for HF Spray Chamber

21-809-2555



PuraFlex Transfer Tube

21-809-2735

Connects spray chamber to torch.
Requires adjustable mount 21-100-0200,
or for HF, 21-809-2555.



Torches

D-Torch 30-808-3052

Comprises:

- Base and Inner Tube 31-808-3146
- Quartz Outer Tube 31-808-3062
- Retaining Ring for Outer Tube 31-808-2818
- Retaining Ring for Injector 31-808-2921



D-Torch Options:

- Ceramic Outer Tube 31-808-3092



Tapered Injectors for D-Torch

- Quartz Injector 0.8mm 31-808-3195
- Quartz Injector 1.5mm 31-808-3058
- Quartz Injector 1.5mm with Ball Joint 31-808-3150
- Quartz Injector 2.4mm with Ball Joint 31-808-2925



Alumina Injectors for D-Torch

- Alumina Injector 1.5mm 31-808-3230
- Alumina Injector 1.8mm 31-808-3160



Sapphire Injectors for D-Torch

- Sapphire Injector 2.0mm 31-808-3312

Semi Demountable Torch with Quartz Injector 30-808-0542

Comprises:

- Torch Body, Quartz 31-808-0541
- Torch Adaptor 8/44 31-808-2638
- Tapered Quartz Injector 1.5mm 31-808-0543
- GazFit Connectors (PKT 4) for 6mm OD side arms GAZ-06



Semi Demountable Torch HF with Alumina Injector 30-808-0942

Comprises:

- Torch Body, Quartz 31-808-0541
- Torch Adaptor 8/44 31-808-2638
- Tapered Alumina Injector 1.8mm 31-808-0938
- GazFit Connectors (PKT 4) for 6mm OD side arms GAZ-06



Tapered Injectors for Semi Demountable Torch

- Quartz Injector 1.0mm 31-808-0544
- Quartz Injector 1.5mm 31-808-0543
- Quartz Injector 1.8mm 31-808-0545
- Quartz Injector 2.4mm 31-808-0400



Torches

(continued)

Fixed Torches

- Quartz Torch, 0.8mm Injector 30-807-0539



- Quartz Torch, Low Flow, 1.5mm Injector 30-800-0015



- Quartz Torch, High Solids, 1.8mm Injector 30-808-1182

Fixed Torches for All Glass System

- Quartz Torch with Ball Joint and 1.8mm Injector High Solids 30-807-0536
- Quartz Torch with Ball Joint and 2.4mm Injector High Solids 30-807-0569



- Quartz Torch Bonnet 31-800-0003



RF Coils

RF Coils for Vista Radial

Gold 70-900-1001G



Silver 70-900-1001S



Silver, Teflon Coated 70-900-1001ST

Installation kit 70-900-1001T



RF Coils for 700ES Radial

Gold 70-900-1005G



Silver 70-900-1005S



Silver, Teflon Coated 70-900-1005ST

Installation kit 70-900-1005T



Common Accessories

Elegra Argon Humidifier

Elegra Argon Humidifier 70-803-1265



Guardian In-Line Filters

Guardian DC in-line non-return gas filter 70-803-1942

Guardian in-line sample filter 70-803-1108



Trident Internal Standard Kits

Trident CT Standard Kit 60-703-1179

Standard Kit for HF 60-808-1150



Autosampler Probes

(See page 14 for complete list of probes)

For Cetac ASX-520

Polyimide sheathed Autosampler Probe 0.5mm ID 60-808-1186L

PTFE Encapsulated Carbon Fibre Probe 0.5mm ID 70-803-0784

PTFE Encapsulated Carbon Fibre Probe 0.75mm ID 70-803-1443

PTFE Encapsulated Carbon Fibre Probe 1.0mm ID 70-803-0793

For SPS 3/SPS 4

PTFE Encapsulated Carbon Fibre Probe 0.75mm ID 70-803-0908

PTFE Encapsulated Carbon Fibre Probe 1.0mm ID 70-803-0853



Glass DC Nebulizers

SeaSpray

2mL/min uptake	A23-1-USS2
1mL/min uptake	A23-1-USS1
400µL/min uptake	A23-1-USS04

MicroMist

400µL/min uptake	A23-1-UM04
200µL/min uptake	A23-1-UM02
100µL/min uptake	A23-1-UM01
50µL/min uptake	A23-1-UM005



Quartz DC Nebulizers

SeaSpray

1mL/min uptake	A23-1-QSS1
----------------	------------



DC Nebulizers for HF

OpalMist

400µL/min uptake	A23-1-PFA04
200µL/min uptake	A23-1-PFA02
100µL/min uptake	A23-1-PFA01
50µL/min uptake	A23-1-PFA005



Spray Chambers

Twister

50mL Cyclonic	20-809-4417HE
---------------	---------------



Tracey

50mL Cyclonic	20-809-4419HE
---------------	---------------



Twinnabar

20mL Cyclonic	20-809-4482HE
---------------	---------------

Cinnabar

20mL Cyclonic	20-809-4480HE
---------------	---------------

Spray Chambers

Single-Cell Spray Chamber Kit

High Sensitivity Single-Cell Sample Introduction System	KT-1184
---	---------



Torches

D-Torch

30-808-3927

Comprises:

Base and Inner Tube	31-808-3928
Quartz Outer Tube	31-808-3942
Retaining Ring	31-808-2818



Quartz Injectors

Tapered 1.0mm	31-808-3423
Tapered 1.5mm	31-808-4004
Tapered 1.8mm	31-808-4005
Tapered 2.0mm	31-808-4006
Tapered 2.5mm	31-808-3302



HF Resistant Injectors

Tapered Alumina 2.4mm	31-808-3205
Sapphire 2.4mm	31-808-3378



Cones

Sampler Cones

Nickel Sampler PE3011-Ni



Aluminium Sampler PE3011-Al

Platinum Sampler PE3013-Pt

Platinum Sampler (18mm) PE3013A-Pt

Platinum Sampler Boron Free PE3013-Pt-BF

Skimmer Cones

Nickel Skimmer PE3012-Ni



Aluminium Skimmer PE3012-Al

Platinum Skimmer PE3014-Pt

Platinum Skimmer Boron Free PE3014-Pt-BF

Hyper Skimmer PE3015-Al

Platinum Hyper Skimmer PE3015-Pt/Ni

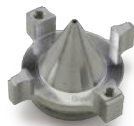

O-ring for NexION Hyper Skimmer Cone (pack of 5) PE5115



Screw for NexION Hyper Skimmer Cone (pack of 2) PE5116



ConeGuard Thread Protectors

Sampler Cone Guard For NexION 1000/2000 70-803-1024



Skimmer Cone Guard For NexION 1000/2000 70-803-1026



Gasket for Sampler Cone (pack of 5) PE5111



Common Accessories

Elegra Argon Humidifier

Elegra Dual Two-channel Argon Humidifier 70-803-1473



Guardian In-Line Filters

Guardian DC in-line non-return gas filter 70-803-1942

Guardian in-line sample filter 70-803-1108

Fitting only connects to 1.3mm and 1.6mm Autosampler Tubing



Trident Internal Standard Kits

Trident CT Standard Kit 60-703-1179

Standard Kit for HF 60-808-1150



Autosampler Probes

(See page 14 for complete list of probes)

Suitable for Cetac ASX-520

Polyimide sheathed Autosampler Probe 0.5mm ID 60-808-1186L

PTFE Encapsulated Carbon Fibre Probe 0.5mm ID 70-803-0784

PTFE Encapsulated Carbon Fibre Probe 0.75mm ID 70-803-1443

PTFE Encapsulated Carbon Fibre Probe 1.0mm ID 70-803-0793



Suitable for PE S10 or AS93+

PTFE Encapsulated Carbon Fibre Probe 0.25mm ID 70-803-1071

PTFE Encapsulated Carbon Fibre Probe 0.5mm ID 70-803-1440

PTFE Encapsulated Carbon Fibre Probe 1.0mm ID 70-803-0816



Glass DC Nebulizers

SeaSpray

1mL/min uptake	A22-1-USS1
400µL/min uptake	A22-1-USS04

MicroMist

400µL/min uptake	A22-1-UM04
200µL/min uptake	A22-1-UM02
100µL/min uptake	A22-1-UM01
50µL/min uptake	A22-1-UM005



DC Nebulizers for HF

OpalMist

400µL/min uptake	A22-1-PFA04
200µL/min uptake	A22-1-PFA02
100µL/min uptake	A22-1-PFA01
50µL/min uptake	A22-1-PFA005



IsoMist XR

Programmable Temperature Cyclonic Spray Chamber

Glass Spray chamber	KT-1096-XR
Quartz spray chamber	KT-1096Q-XR
PFA spray chamber	KT-1096P-XR
Twinnabar spray chamber	KT-1096T-XR



Spray Chambers

Twister

50mL Cyclonic (2.4mm Aux. Port) 90deg Screw Mount	20-809-3854HE
---	---------------



Twister

50mL Cyclonic with Screw Mount	20-809-3892HE
-----------------------------------	---------------

Twinnabar

20mL Cyclonic	20-809-3650HE
---------------	---------------



Cinnabar

20mL Cyclonic	20-809-3709HE
---------------	---------------



Spray Chambers for HF

Tracey PFA44

44mL Cyclonic	20-809-3713
---------------	-------------



Torches

D-Torch

30-807-0540

Comprises:

Base and Inner Tube	31-808-2847
Quartz Outer Tube	31-808-2848
Retaining Ring	31-808-2818



D-Torch for HF

30-808-2937

Comprises:

Base and Inner Tube	31-808-2847
Ceramic Outer Tube	31-808-2849
Retaining Ring	31-808-2818



D-Torch Options:

Quartz Outer Tube	31-808-2848
Ceramic Outer Tube	31-808-2849



Quartz Torch

Standard Quartz Torch	30-808-8107
High Efficiency Quartz Torch	31-808-2784



Quartz Injectors (non DRC)

Tapered Quartz Injector 1.0mm	31-808-0370
Tapered Quartz Injector 1.2mm	31-808-0789
Tapered Quartz Injector 1.5mm	31-807-0006
Tapered Quartz Injector 1.8mm	31-807-0005
Tapered Quartz Injector 2.0mm	31-807-0004

These injectors are compatible with both D-Torch and standard torch. They are suitable for torch adaptor 31-808-2825.



Torches

(continued)

Quartz Injectors (DRC Versions)

- Tapered Quartz Injector with Ball Joint, 0.85mm 31-808-3125
- Tapered Quartz Injector with Ball Joint, 1.5mm 31-808-0851
- Tapered Quartz Injector with Ball Joint, 2.0mm 31-808-0806
- Tapered Quartz Injector with Ball Joint, 2.5mm 31-808-3463

These injectors are compatible with both D-Torch and standard torch. They are suitable for torch adaptor 31-808-2824.



HF Resistant Injectors

- Tapered Alumina Injector 1.5mm 31-807-0044
- Tapered Alumina Injector 1.8mm 31-807-0045
- Tapered Alumina Injector 2.0mm 31-807-0060
- Sapphire Injector 2.0mm 31-808-2803
- Platinum Injector 2.0mm 31-808-2972

These injectors are compatible with both D-Torch and standard torch. They are suitable for torch adaptor 31-808-2825.



Torch Adaptor

- Cassette Mount Adaptor for Ball Joint Injector 31-808-2824

This adaptor is suitable for injectors with a ball joint.



Torch Adaptor

- PFA Cassette Mount Adaptor 31-808-2825

This adaptor is suitable for injectors without a ball joint.



Cones

Sampler Cones

- Nickel Sampler PE3011-Ni
- Aluminium Sampler PE3011-Al
- Platinum Sampler PE3013-Pt



- Platinum Sampler Boron free PE3013-Pt-BF

Cones

(continued)

Skimmer Cones

- Nickel Skimmer PE3012-Ni
- Aluminium Skimmer PE3012-Al
- Platinum Skimmer PE3014-Pt
- Platinum Skimmer Boron free PE3014-Pt-BF
- Hyper Skimmer PE3015-Al
- Platinum Hyper Skimmer PE3015-Pt/Ni



- O-ring for NexION Hyper Skimmer Cone (pack of 5) PE5115



- Screw for NexION Hyper Skimmer Cone (pack of 2) PE5116



ConeGuard Thread Protectors

- Sampler Cone Guard For NexION 300/350 70-803-1024



- Skimmer Cone Guard For NexION 300/350 70-803-1026



- Gasket for Sampler Cone (pack of 5) PE5111



RF Coils

- Copper 70-900-2006C



- RF Coil Installation Kit 70-900-2006T



Common Accessories

Elegra Argon Humidifier

Elegra Dual Two-channel
Argon Humidifier 70-803-1274



Guardian In-Line Filters

Guardian DC in-line non-return
gas filter 70-803-1942

Guardian in-line sample filter 70-803-1108

Fitting only connects to 1.3mm and 1.6mm
Autosampler Tubing



Trident Internal Standard Kits

Trident CT Standard Kit 60-703-1179

Standard Kit for HF solutions 60-808-1150



Autosampler Probes

(See page 14 for complete list of probes)

Suitable for Cetac ASX-520

Polyimide sheathed Autosampler Probe
0.5mm ID 60-808-1186L

PTFE Encapsulated Carbon Fibre Probe
0.5mm ID 70-803-0784

PTFE Encapsulated Carbon Fibre Probe
0.75mm ID 70-803-1443

PTFE Encapsulated Carbon Fibre Probe
1.0mm ID 70-803-0793

Suitable for PE S10 or AS93+

PTFE Encapsulated Carbon Fibre Probe
0.25mm ID 70-803-1071

PTFE Encapsulated Carbon Fibre Probe
0.5mm ID 70-803-1440

PTFE Encapsulated Carbon Fibre Probe
1.0mm ID 70-803-0816



Glass DC Nebulizers

SeaSpray

2mL/min uptake A21-07-USS2
 400µL/min uptake A21-07-USS04

MicroMist

600µL/min uptake A21-07-UM06
 200µL/min uptake A21-07-UM02
 100µL/min uptake A21-07-UM01
 50µL/min uptake A21-07-UM005



Slurry

4mL/min uptake A21-07-US6

Conikal

2mL/min uptake A21-07-UC2
 1mL/min uptake A21-07-UC1

DC Nebulizers for HF

DuraMist

1mL/min uptake A21-07-DM1
 400µL/min uptake A21-07-DM04



OpalMist

2mL/min uptake A21-07-PFA2
 600µL/min uptake A21-07-PFA06
 200µL/min uptake A21-07-PFA02
 100µL/min uptake A21-07-PFA01
 50µL/min uptake A21-07-PFA005



VeeSpray

0.6-3mL/min uptake A21-07-CV6



IsoMist XR

Programmable Temperature Cyclonic Spray Chamber

Glass Spray Chamber KT-1147-XR
 Quartz Spray Chamber KT-1147Q-XR
 PFA Spray Chamber KT-1147P-XR



Spray Chambers

Twister

50mL Cyclonic 20-809-0495HE



Tracey

50mL Cyclonic 20-808-8882HE



Cinnabar

20mL Cyclonic 20-809-0164HE



Twinnabar

20mL Cyclonic 20-809-0498HE



HydraMist Simultaneous Cold Vapor/ Pneumatic Nebulization Spray Chamber

Hydride Kit KT-1157



Spray Chambers for HF

Twister TFE

50mL Cyclonic 20-809-3452



Tracey TFE

50mL Cyclonic 20-809-2507



Torches

D-Torch for Avio 200

D-Torch 30-808-3800



Comprises:

Base and Inner Tube 31-808-3802

Quartz Outer Tube 31-808-3792

Retaining Ring 31-808-2818

D-Torch Options:

Ceramic Outer Tube 31-808-3820

Injector Adapter 31-808-3782

Viton O-Rings (Pkt 10) 70-803-1576



D-Torch for Avio 500

D-Torch 30-808-3882



Comprises:

Base and Inner Tube 31-808-3883

Quartz Outer Tube 31-808-3792

Retaining Ring 31-808-2818

D-Torch Options:

Ceramic Outer Tube 31-808-3894

Injector Adapter 31-808-3782

Viton O-Rings (Pkt 10) 70-803-1576



Tapered Injectors for D-Torch

Quartz Injector 0.8mm 31-808-3785

Quartz Injector 1.2mm 31-808-3786

Quartz Injector 1.6mm 31-808-3788

Quartz Injector 2.0mm 31-808-3789

Quartz Injector 3.0mm 31-808-3790

Alumina Injector 1.25mm 31-808-3799

Alumina Injector 2.0mm 31-808-3783



Capillary Injectors for D-Torch

Quartz Injector 1.2mm 31-808-3787

Sapphire Injector 2.0mm 31-808-3784

Fixed Torch for Avio 200/500

Quartz Torch with single slot 31-808-3776

Quartz Torch with 3 slots 31-808-4233



Common Accessories

Elegra Argon Humidifier

Elegra Argon Humidifier 70-803-1269



Guardian In-Line Filters

Guardian DC in-line non-return gas filter 70-803-1942

Guardian in-line sample filter 70-803-1108

Fitting only connects to 1.3mm and 1.6mm Autosampler Tubing



Trident Internal Standard Kits

Trident CT Standard Kit 60-703-1179

Standard Kit for HF 60-808-1150



Autosampler Probes

(See page 14 for complete list of probes)

Suitable for Cetac ASX-520

Polyimide sheathed Autosampler Probe 0.5mm ID 60-808-1186L

PTFE Encapsulated Carbon Fibre Probe 0.5mm ID 70-803-0784

PTFE Encapsulated Carbon Fibre Probe 0.75mm ID 70-803-1443

PTFE Encapsulated Carbon Fibre Probe 1.0mm ID 70-803-0793

Suitable for PE S10 or AS93+

PTFE Encapsulated Carbon Fibre Probe 0.25mm ID 70-803-1071

PTFE Encapsulated Carbon Fibre Probe 0.5mm ID 70-803-1440

PTFE Encapsulated Carbon Fibre Probe 1.0mm ID 70-803-0816



Glass DC Nebulizers

SeaSpray

2mL/min uptake	A21-07-USS2
400µL/min uptake	A21-07-USS04

MicroMist

600µL/min uptake	A21-07-UM06
200µL/min uptake	A21-07-UM02
100µL/min uptake	A21-07-UM01
50µL/min uptake	A21-07-UM005



Conikal

2mL/min uptake	A21-07-UC2
1mL/min uptake	A21-07-UC1

Slurry

4mL/min uptake	A21-07-US6
----------------	------------

DC Nebulizers for HF

DuraMist

1mL/min uptake	A21-07-DM1
400µL/min uptake	A21-07-DM04



OpalMist

2mL/min uptake	A21-07-PFA2
600µL/min uptake	A21-07-PFA06
200µL/min uptake	A21-07-PFA02
100µL/min uptake	A21-07-PFA01
50µL/min uptake	A21-07-PFA005



VeeSpray

0.6 - 3mL/min uptake	A21-07-CV6
----------------------	------------



IsoMist XR

Programmable Temperature Cyclonic Spray Chamber

Glass spray chamber	KT-1012-XR
Quartz Spray Chamber	KT-1021Q-XR
PFA spray chamber	KT-1012P-XR



Spray Chambers

Tracey

50mL Cyclonic	20-809-0434HE
---------------	---------------



Twister

50mL Cyclonic (Aqueous) With 7mm baffle	20-809-0208HE
--	---------------



Twister

50mL Cyclonic (Organics) With 4mm baffle	20-809-0446HE
---	---------------



Twister

50mL Cyclonic (Aux. Port)	20-809-0004HE
---------------------------	---------------



Cinnabar

20mL Cyclonic	20-809-9121HE
---------------	---------------



HydraMist Simultaneous Cold Vapor/ Pneumatic Nebulization Spray Chamber

HydraMist Kit	KT-1162
---------------	---------



Spray Chambers for HF

Tracey TFE

50mL Cyclonic	20-809-2510
Plugs directly into cassette mount	



Torches

D-Torch 30-808-3300

Comprises:

- Base and Inner Tube 31-808-3292
- Quartz Outer Tube 31-808-3294
- Retaining Ring 31-808-2818



D-Torch Options

- Ceramic Outer Tube 31-808-2990
- Quartz Outer Tube (No Slot) 31-808-3407
- Copper Foils (PKT 12) for Ceramic Outer Tube 31-808-3356



Quartz Torch

- Without slots 31-808-3254
- With single slot 31-808-3255
- With 3 slots 31-808-3256

Quartz Torch Options:

- Copper Foil for Quartz Torch or D-Torch Quartz Outer Tube (pack of 12) 31-808-3289

Tapered Quartz Injectors

- Quartz Injector 0.8mm 31-808-3257
- Quartz Injector 2.0mm 31-808-3258
- Quartz Injector 2.5mm 31-808-3730
- Quartz Injector 3.0mm 31-808-3259
- Alumina Injector 1.2mm 31-808-3287
- Alumina Injector 2.0mm 31-808-3286



Sapphire Injectors

- Sapphire Injector 2mm 31-808-3528

Purge Windows

- Axial 17mm disk 31-808-0551
- Axial 32mm disk 31-808-2649
- Radial (Post Nov. 2004) 31-808-2788

Common Accessories

Elegra Argon Humidifier

Elegra Argon Humidifier 70-803-1269



Guardian In-Line Filters

Guardian DC in-line non-return gas filter 70-803-1942

Guardian in-line sample filter 70-803-1108

Fitting only connects to 1.3mm and 1.6mm Autosampler Tubing



Trident Internal Standard Kits

Trident CT Standard Kit 60-703-1179

Standard Kit for HF solutions 60-808-1150



Autosampler Probes

(See page 14 for complete list of probes)

Suitable for Cetac ASX-520

Polyimide sheathed Autosampler Probe 0.5mm ID 60-808-1186L

PTFE Encapsulated Carbon Fibre Probe 0.5mm ID 70-803-0784

PTFE Encapsulated Carbon Fibre Probe 0.75mm ID 70-803-1443

PTFE Encapsulated Carbon Fibre Probe 1.0mm ID 70-803-0793

Suitable for PE S10 or AS93+

PTFE Encapsulated Carbon Fibre Probe 0.25mm ID 70-803-1071

PTFE Encapsulated Carbon Fibre Probe 0.5mm ID 70-803-1440

PTFE Encapsulated Carbon Fibre Probe 1.0mm ID 70-803-0816



Glass DC Nebulizers

SeaSpray

2mL/min uptake	A21-07-USS2
400µL/min uptake	A21-07-USS04

MicroMist

600µL/min uptake	A21-07-UM06
200µL/min uptake	A21-07-UM02
100µL/min uptake	A21-07-UM01
50µL/min uptake	A21-07-UM005



Conikal

2mL/min uptake	A21-07-UC2
1mL/min uptake	A21-07-UC1

Slurry

4mL/min uptake	A21-07-US6
----------------	------------

DC Nebulizers for HF

DuraMist

1mL/min uptake	A21-07-DM1
400µL/min uptake	A21-07-DM04



OpalMist

2mL/min uptake	A21-07-PFA2
600µL/min uptake	A21-07-PFA06
200µL/min uptake	A21-07-PFA02
100µL/min uptake	A21-07-PFA01
50µL/min uptake	A21-07-PFA005



VeeSpray

0.6 - 3mL/min uptake	A21-07-CV6
----------------------	------------



IsoMist XR

Programmable Temperature Cyclonic Spray Chamber

Glass Spray Chamber	KT-1012-XR
Quartz Spray Chamber	KT-1012Q-XR
PFA Spray Chamber	KT-1012P-XR



Spray Chambers

Tracey

50mL Cyclonic	20-809-0434HE
---------------	---------------



Twister

50mL Cyclonic (Aqueous) With 7mm baffle	20-809-0208HE
--	---------------



Twister

50mL Cyclonic (Organics) With 4mm baffle	20-809-0446HE
---	---------------



Twister

50mL Cyclonic (Aux. Port)	20-809-0004HE
---------------------------	---------------



Cinnabar

20mL Cyclonic	20-809-9121HE
---------------	---------------



HydraMist Simultaneous Cold Vapor/ Pneumatic Nebulization Spray Chamber

HydraMist Kit	KT-1162
---------------	---------

Spray Chambers for HF

Tracey TFE

50mL Cyclonic	20-809-2510
Plugs directly into cassette mount	



Torches

D-Torch 30-808-2926

Comprises:

- Base and Inner Tube 31-808-2981
- Quartz Outer Tube 31-808-2986
- Retaining Ring 31-808-2818



D-Torch Options:

- Ceramic Outer Tube 31-808-3365
- Quartz Outer Tube (3 slots) 31-808-3436
- Copper Foils (PKT 12) for Ceramic Outer Tube 31-808-3377



Quartz Torches

- JAZ with single slot 30-808-0845
- Without slot 30-808-1122
- With 3 slots 30-808-1470



Quartz Torch Options:

- Copper Foils (PKT 12) for D-Torch Outer Tube and Quartz Torch 31-808-2645



Tapered Injectors

- Quartz Injector 1.2mm 31-808-1154
- Quartz Injector 2.0mm 31-807-0075
- Quartz Injector 3.0mm 31-808-2506
- Alumina Injector 1.2mm 31-808-3982
- Alumina Injector 2.0mm 31-808-1210
- Alumina Injector 2.4mm 31-808-2771
- Sapphire Injector 2.0mm 31-808-2774



Capillary Injectors

- Quartz Injector 1.0mm 31-808-0939
- Quartz Injector 1.8mm 31-808-0794



Torch Bonnet 31-800-0018



Purge Windows

- Axial 17mm disk for 4000/5000 7000/8000DV 31-808-0551
- Axial 32mm disk for 7000DV 31-808-2649
- Radial for 5000/7000DV (Post Nov. 2004) 31-808-2788

RF Coils

- Silver 70-900-2003S
- Gold 70-900-2003G



RF Coil Installation Kit 70-900-2003T



Common Accessories

Elegra Argon Humidifier

Elegra Argon Humidifier 70-803-1269



Guardian In-Line Filters

- Guardian DC in-line non-return gas filter 70-803-1942
 - Guardian in-line sample filter 70-803-1108
- Fitting only connects to 1.3mm and 1.6mm Autosampler Tubing



Trident Internal Standard Kits

- Trident CT Standard Kit 60-703-1179
- Standard Kit for HF solutions 60-808-1150



Autosampler Probes

(See page 14 for complete list of probes)

Suitable for Cetac ASX-520

- Polyimide sheathed Autosampler Probe 0.5mm ID 60-808-1186L
- PTFE Encapsulated Carbon Fibre Probe 0.5mm ID 70-803-0784
- PTFE Encapsulated Carbon Fibre Probe 0.75mm ID 70-803-1443
- PTFE Encapsulated Carbon Fibre Probe 1.0mm ID 70-803-0793

Suitable for PE S10 or AS93+

- PTFE Encapsulated Carbon Fibre Probe 0.25mm ID 70-803-1071
- PTFE Encapsulated Carbon Fibre Probe 0.5mm ID 70-803-1440
- PTFE Encapsulated Carbon Fibre Probe 1.0mm ID 70-803-0816



Glass DC Nebulizers

SeaSpray

2mL/min uptake	A21-07-USS2
400µL/min uptake	A21-07-USS04

MicroMist

600µL/min uptake	A21-07-UM06
200µL/min uptake	A21-07-UM02
100µL/min uptake	A21-07-UM01
50µL/min uptake	A21-07-UM005



Conikal

2mL/min uptake	A21-07-UC2
1mL/min uptake	A21-07-UC1

Slurry

4mL/min uptake	A21-07-US6
----------------	------------

DC Nebulizers for HF

DuraMist

1mL/min uptake	A21-07-DM1
400µL/min uptake	A21-07-DM04



OpalMist

2mL/min uptake	A21-07-PFA2
600µL/min uptake	A21-07-PFA06
200µL/min uptake	A21-07-PFA02
100µL/min uptake	A21-07-PFA01
50µL/min uptake	A21-07-PFA005



VeeSpray

0.6 - 3mL/min uptake	A21-07-CV6
----------------------	------------



IsoMist XR

Programmable Temperature Cyclonic Spray Chamber

Glass Spray Chamber	KT-1011-XR
Quartz Spray Chamber	KT-1011Q-XR
PFA Spray Chamber	KT-1011P-XR



Spray Chambers

Twister

50mL Cyclonic	20-809-0495HE
---------------	---------------



Spray Chambers for HF

Tracey TFE

50mL Cyclonic	20-809-2507
---------------	-------------



Torches

D-Torch

30-808-2832

Comprises:

Base and Inner Tube	31-808-2809
Quartz Outer Tube	31-808-2821
Retaining Ring	31-808-2818



D-Torch Options:

Ceramic Outer Tube	31-808-2815
--------------------	-------------



Quartz Torch

With 3 slots	30-807-0064
With 3 slots (Long life)	30-808-3593



Tapered Quartz Injectors

Quartz Injector 1.0mm	31-808-0119
Quartz Injector 1.5mm	31-808-0124
Quartz Injector 1.8mm	31-807-0008
Quartz Injector 2.0mm	31-807-0050



Tapered Alumina Injectors

Alumina Injector 1.8mm	31-807-0052
Alumina Injector 2.0mm	31-808-1352



Capillary Alumina Injectors

Alumina Injector 2.0mm	31-808-2625
------------------------	-------------



Torches

Torch Bonnet 31-800-0018



Purge Extension Window for 4300/5300/7300V 31-808-1345



RF Coils

Silver 70-900-2003S

Gold 70-900-2003G



RF Coil Installation Kit 70-900-2003T



Common Accessories

Elegra Argon Humidifier

Elegra Argon Humidifier 70-803-1269



Guardian In-Line Filters

Guardian DC in-line non-return gas filter 70-803-1942

Guardian in-line sample filter 70-803-1108

Fitting only connects to 1.3mm and 1.6mm Autosampler Tubing



Trident Internal Standard Kits

Trident CT Standard Kit 60-703-1179

Standard Kit for HF solutions 60-808-1150



Autosampler Probes

(See page 14 for complete list of probes)

Suitable for Cetac ASX-520

Polyimide sheathed Autosampler Probe
0.5mm ID 60-808-1186L

PTFE Encapsulated Carbon Fibre Probe
0.5mm ID 70-803-0784

PTFE Encapsulated Carbon Fibre Probe
0.75mm ID 70-803-1443

PTFE Encapsulated Carbon Fibre Probe
1.0mm ID 70-803-0793

Suitable for PE S10 or AS93+

PTFE Encapsulated Carbon Fibre Probe
0.25mm ID 70-803-1071

PTFE Encapsulated Carbon Fibre Probe
0.5mm ID 70-803-1440

PTFE Encapsulated Carbon Fibre Probe
1.0mm ID 70-803-0816



Glass DC Nebulizers

Conikal
1mL/min uptake A41-1-UC1S

SeaSpray
400µL/min uptake A41-07-USS04

Slurry
4mL/min uptake A41-1-US6

MicroMist
600µL/min uptake A41-07-UM06S
200µL/min uptake A41-07-UM02
100µL/min uptake A41-07-UM01
50µL/min uptake A41-07-UM005



Quartz DC Nebulizers

SeaSpray
1mL/min uptake A41-1-QSS1



DC Nebulizers Compatible with HF

OpalMist
1mL/min uptake A41-1-PFA1S
400µL/min uptake A41-07-PFA04
200µL/min uptake A41-07-PFA02
100µL/min uptake A41-07-PFA01
50µL/min uptake A41-07-PFA005



DuraMist
1mL/min uptake A41-1-DM1S
400µL/min uptake A41-07-DM04



VeeSpray
0.6 - 3mL/min uptake A41-1-CV6



Spray Chambers

Glass
50mL Cyclonic 21-809-3994
With B14 gravity drain



Quartz
50mL Cyclonic 21-809-3992
With B14 gravity drain



Drain Device 21-808-8214



Extention Pipe
Glass Extention w/ right angle 31-808-3920



Spray Chambers Compatible with HF

PFA
50mL Cyclonic 21-809-3991



HF Drain Device 21-809-2540



Extention Pipe
PFA Extention w/ right angle 21-809-4081



Torches

Quartz Torches

Quartz Mini Torch (Suitable for ICP-MS 2030)	30-807-0567
Torch with 1.2mm Injector (Suitable for ICP-MS 8500)	30-808-9986
Torch with 1.5mm Injector (Suitable for ICP-MS 8500)	30-808-1090
Quartz Sleeve for Mini Torch (Suitable for ICP-MS 2030)	31-808-4214



RF Coils

Copper	70-900-6000C
Silver	70-900-6000S
Gold	70-900-6000G



RF Coil Installation Kit

RF Coil Installation Kit	70-900-6000T
--------------------------	--------------

Cones

Sampler Cones

Copper Sampler	SZ7001-Cu	
Nickel Sampler	SZ7001-Ni	
Nickel Sampler with Copper Base	SZ7001-Ni/Cu	
Platinum Sampler (10mm Insert)	SZ7003-Pt/Cu	
Platinum Sampler (15mm Insert)	SZ7003A-Pt/Cu	
Gasket for Sampler Cone (PKT 3)	SZ5001	
Screw Kit for Sampler Cone (PKT 4)	SZ5004	
O-Ring Kit	70-803-1908	

Cones

(continued)

Skimmer Cones



Copper Skimmer	SZ7002-Cu	
Nickel Skimmer	SZ7002-Ni	
Nickel Skimmer with Copper Base	SZ7002-Ni/Cu	
Platinum Skimmer	SZ7004-Pt/Cu	
Screw Kit for Skimmer Cone (PKT 2)	SZ5002	
Cone Extraction Tool	70-803-1573	

Common Accessories

Elegra Argon Humidifier

Elegra Argon Humidifier	70-803-1312	
-------------------------	-------------	--

Guardian In-Line Filters

Guardian DC in-line non-return gas filter	70-803-1942	
Guardian in-line sample filter	70-803-1108	

Trident Internal Standard Kits

Trident CT Standard Kit	60-703-1179	
Standard Kit for HF	60-808-1150	

Autosampler Probes

(See page 14 for complete list of probes)

For Shimadzu® ASC-6100F/9800

PTFE Sheathed Carbon Fibre Probe 0.3mm ID with UniFit	70-803-1200	
--	-------------	---

For Shimadzu® AS10

PTFE Sheathed Carbon Fibre Probe 0.75mm ID with UniFit	70-803-1477	
---	-------------	--

Glass DC Nebulizers

Conikal
1mL/min uptake A41-1-UC1S

SeaSpray
2mL/min uptake A41-1-USS2S

Slurry
4mL/min uptake A41-1-US6

MicroMist
600µL/min uptake A41-07-UM06S
200µL/min uptake A41-07-UM02
100µL/min uptake A41-07-UM01
50µL/min uptake A41-07-UM005



DC Nebulizers for HF

OpalMist
1mL/min uptake A41-07-PFA1S
600µL/min uptake A41-07-PFA06S
200µL/min uptake A41-07-PFA02
100µL/min uptake A41-07-PFA01
50µL/min uptake A41-07-PFA005



DuraMist
1mL/min uptake A41-07-DM1S
400µL/min uptake A41-07-DM04



VeeSpray
0.6 - 3mL/min uptake A41-1-CV6



IsoMist XR

Programmable Temperature Cyclonic Spray Chamber

Glass spray chamber KT-1067-XR
Quartz spray chamber KT-1067Q-XR
PFA spray chamber KT-1067P-XR



Spray Chambers

Tracey
50mL Cyclonic 20-808-8881HE
With B14 gravity drain



Twister
50mL Cyclonic 20-809-9119HE
With B14 gravity drain



Twister
50mL Cyclonic 20-809-0222HE



Cinnabar
20mL Cyclonic 20-809-0164HE



HydraMist Simultaneous Cold Vapor/ Pneumatic Nebulization Spray Chamber

Hydride Kit KT-1157



Drain Device 21-808-8214



Transfer Tube, Spray Chamber to ICPE-9000/9800 Torch

Glass Transfer Tube 86mm 21-809-2846



Spray Chambers for HF

Tracey TFE

50mL Cyclonic 20-809-2508
 With B14 gravity drain
 Suitable for use with HF



HF Drain Device

21-809-2540



Mounting bracket for HF Spray Chamber

21-809-2839



Transfer Tube, Spray Chamber to ICPE-9000/9800 Torch

PFA Transfer Tube 82.5mm 31-808-3071



Torches

Semi Demountable Torch (HF)

30-808-8039

Suitable for ICPS-7500/8100 and ICPE-9000/9800

Comprises:

Torch Body 31-808-1258
 Torch Adaptor 31-808-1260
 Tapered Alumina Injector 1.5mm 31-808-0013
 Joint Clip 14/23 KCP-14
 GazFit Connectors (PKT 4) for 4mm OD side arms GAZ-04



Injectors for Semi Demountable Torch

Alumina Injector 1.0mm 31-808-0835
 Alumina Injector 1.5mm 31-808-0013
 Alumina Injector 1.8mm 31-808-0015
 Alumina Injector 2.0mm 31-808-0027
 Alumina Injector 2.4mm 31-808-0385
 Sapphire Injector 2.0mm 31-808-3001



Torches

D-Torch

30-808-3910

Suitable for ICPE-9000/9800

Comprises:

Torch Body 31-808-3998
 Torch Adaptor 31-808-3072
 Injector Ferrule 6.0mm 31-808-2962
 Quartz Outer Tube 31-808-3912
 Outer Tube Retainer 31-808-2818
 GazFit Connectors (PKT 4) for 4mm OD side arms GAZ-04

D-Torch Options:

Quartz Outer Tube 31-808-3912

Tapered Injectors for D-Torch

Alumina Injector 1.5mm 31-808-3964
 Quartz Injector 1.0mm 31-808-3965
 Quartz Injector 1.5mm 31-808-3966
 Quartz Injector 1.8mm 31-808-3967



Quartz Torches

Quartz Torch Standard 1.5mm Injector (Suitable for 7500/8100) 30-808-1179
 Quartz Torch for Organics, 1.0mm Injector (Suitable for 7500/8100/9000/9800) 30-807-0519
 Quartz Torch for High TDS, 1.8mm Injector (Suitable for 7500/8100/9000/9800) 30-807-0518
 Quartz Torch for High TDS, 2.0mm Injector (Suitable for 7500/8100/9000/9800) 30-807-0564
 Quartz Mini Torch 1.5mm Injector (Suitable for ICPE-9000/9800) 30-807-0534

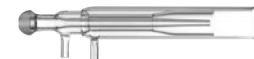

RF Coils

Copper	70-900-6100C
Silver	70-900-6100S
Gold	70-900-6100G



RF Coil Installation Kit 70-900-6100T

Common Accessories

Elegra Argon Humidifier

Elegra Argon Humidifier 70-803-1312



Guardian In-Line Filters

Guardian DC in-line non-return gas filter 70-803-1942

Guardian in-line sample filter 70-803-1108



Trident Internal Standard Kits

Trident CT Standard Kit 60-703-1179

Standard Kit for HF 60-808-1150



Autosampler Probes

(See page 14 for complete list of probes)

For Shimadzu® ASC-6100F/9800

PTFE Sheathed Carbon Fibre Probe
0.3mm ID with UniFit 70-803-1200

For Shimadzu® AS10

PTFE Coated Vitcon O-rings
(PKT 10) With UniFit 70-803-1477



Glass DC Nebulizers

SeaSpray

2mL/min uptake	A21-07-USS2
1mL/min uptake	A21-07-USS1
400µL/min uptake	A21-07-USS04
2mL/min uptake	A21-1-USS2

MicroMist

600µL/min uptake	A21-07-UM06
200µL/min uptake	A21-07-UM02
100µL/min uptake	A21-07-UM01
50µL/min uptake	A21-07-UM005



Slurry

4mL/min uptake	A21-07-US6
----------------	------------

Conikal

2mL/min uptake	A21-07-UC2
1mL/min uptake	A21-07-UC1

DC Nebulizers for HF

DuraMist

1mL/min uptake	A21-07-DM1
400µL/min uptake	A21-07-DM04



OpalMist

2mL/min uptake	A21-07-PFA02
600µL/min uptake	A21-07-PFA06
200µL/min uptake	A21-07-PFA02
100µL/min uptake	A21-07-PFA01
50µL/min uptake	A21-07-PFA005



VeeSpray

0.6-3mL/min uptake	A21-07-CV6
--------------------	------------



IsoMist XR

Programmable Temperature Cyclonic Spray Chamber

For ARCOS II EOP

Glass Spray Chamber	KT-1146-XR
Quartz Spray Chamber	KT-1146Q-XR
PFA Spray Chamber	KT-1146P-XR

For Blue TI/EOP

Glass Spray Chamber	KT-1141-XR
Quartz Spray Chamber	KT-1141Q-XR
PFA Spray Chamber	KT-1141P-XR



Spray Chambers

Tracey

50mL Cyclonic	20-809-2665HE
---------------	---------------



Twister

50mL Cyclonic	20-809-2951HE
---------------	---------------



Scott Spray Chamber

20-809-4053

HydraMist Simultaneous Cold Vapor/ Pneumatic Nebulization Spray Chamber

Hydride Kit	KT-1160
-------------	---------



Quartz Adaptor

21-809-3772



Quartz Adaptor with Aux Port

21-809-3771



Spray Chambers for HF

Tracey TFE

50mL Cyclonic	20-809-3717
---------------	-------------

Suitable for use with HF.
Requires Transfer Tube 21-809-3726.



PuraFlex Transfer Tube

21-809-3726



Torches

D-Torch Blue EOP 30-808-3600

D-Torch Blue TI 30-808-3629

Comprises:

Base and Inner Tube 31-808-3605

Quartz Outer Tube 31-808-3630

Injector Ferrule 31-808-2962

Retaining Ring 31-808-3595

Adaptor for D-Torch B19 31-808-3651

Adaptor S19-B19-90deg 21-809-4045

Metal Ball Joint Clip JC-19

D-Torch Options:

Sheath Gas Adaptor 21-809-4082

Aux Gas Line 70-803-1424



Tapered Injectors for Blue EOP/TI D-Torch

Quartz Injector 1.0mm 31-808-0009

Quartz Injector 1.2mm 31-808-3643

Quartz Injector 1.5mm 31-808-0007

Quartz Injector 1.8mm 31-808-8146

Quartz Injector 2.0mm 31-808-0008

Quartz Injector 2.4mm 31-808-3541

Quartz Injector 2.5mm 31-808-3645

Alumina Injector 1.0mm 31-808-0835

Alumina Injector 1.5mm 31-808-0013

Alumina Injector 1.8mm 31-808-0015

Alumina Injector 2.0mm 31-808-0027

Alumina Injector 2.4mm 31-808-0385



Capillary Injectors for Blue EOP/TI D-Torch

Alumina Injector 1.8mm 31-808-0087

D-Torch ARCOS II EOP 30-808-3657

Comprises:

Base and Inner Tube 31-808-3660

Quartz Outer Tube 31-808-3658

Injector Ferrule 31-808-2962

Retaining Ring 31-808-3595

Adaptor for D-Torch B19 31-808-3651

Adaptor S19-B19-90deg 21-809-4045

Metal Ball Joint Clip JC-19

D-Torch Options:

Sheath Gas Adaptor 21-809-4082

Adaptor S19-B13-90deg 21-809-4048

Adaptor assembly 21-809-4223



Torches

Tapered Injectors for ARCOS II EOP D-Torch

Quartz Injector 1.8mm 31-808-3663

Quartz Injector 2.0mm 31-808-3674

Quartz Injector 2.5mm 31-808-3676

Alumina Injector 2.0mm 31-808-3699

Alumina Injector 2.4mm 31-808-3700



Capillary Injectors for ARCOS II EOP D-Torch

Sapphire Injector 2.0mm 31-808-3718

Sapphire Injector 2.4mm 31-808-3850

Common Accessories

Elegra Argon Humidifier

Elegra Argon Humidifier 70-803-1271



Elegra Stand 70-803-1581



Guardian In-Line Filters

Guardian DC in-line non-return gas filter 70-803-1942

Guardian in-line sample filter 70-803-1108



Trident Internal Standard Kits

Trident CT Standard Kit 60-703-1179

Standard Kit for HF 60-808-1150



Autosampler Probes

(See page 14 for complete list of probes)

For Cetac ASX-520

Polyimide sheathed Autosampler Probe 0.5mm ID 60-808-1186L

PTFE Encapsulated Carbon Fibre Probe 0.5mm ID 70-803-0784

PTFE Encapsulated Carbon Fibre Probe 0.75mm ID 70-803-1443

PTFE Encapsulated Carbon Fibre Probe 1.0mm ID 70-803-0793



Glass DC Nebulizers

SeaSpray

2mL/min uptake	A21-07-USS2
1mL/min uptake	A21-07-USS1
400µL/min uptake	A21-07-USS04

MicroMist

600µL/min uptake	A21-07-UM06
200µL/min uptake	A21-07-UM02
100µL/min uptake	A21-07-UM01
50µL/min uptake	A21-07-UM005



Slurry

4mL/min uptake	A21-07-US6
----------------	------------

Conikal

2mL/min uptake	A21-07-UC2
1mL/min uptake	A21-07-UC1

DC Nebulizers for HF

DuraMist

1mL/min uptake	A21-07-DM1
400µL/min uptake	A21-07-DM04



OpalMist

2mL/min uptake	A21-07-PFA02
600µL/min uptake	A21-07-PFA06
200µL/min uptake	A21-07-PFA02
100µL/min uptake	A21-07-PFA01
50µL/min uptake	A21-07-PFA005



VeeSpray

0.6-3mL/min uptake	A21-07-CV6
--------------------	------------



IsoMist XR

Programmable Temperature Cyclonic Spray Chamber

For ARCOS II SOP

Glass Spray Chamber	KT-1154-XR
Quartz Spray Chamber	KT-1154Q-XR
PFA Spray Chamber	KT-1154P-XR

For Blue SOP

Glass Spray Chamber	KT-1141-XR
Quartz Spray Chamber	KT-1141Q-XR
PFA Spray Chamber	KT-1141P-XR



Spray Chambers

Tracey

50mL Cyclonic	20-809-2665HE
---------------	---------------



Twister

50mL Cyclonic	20-809-2951HE
---------------	---------------



HydraMist Simultaneous Cold Vapor/Pneumatic Nebulization Spray Chamber

Hydride Kit	KT-1160
-------------	---------



Straight Quartz Adaptor

21-809-3773



Straight Quartz Adapter with Aux Port

21-809-3804

Spray Chambers for HF

Tracey TFE

50mL Cyclonic	20-809-3717
---------------	-------------

Suitable for use with HF.
Requires Transfer Tube

21-809-3727



Straight HF Resistant Adaptor

21-809-3727

Torches

D-Torch 30-808-3614

Comprises:

- Base and Inner Tube 31-808-3605
- Quartz Outer Tube 31-808-3611
- Injector Ferrule 31-808-2962
- Retaining Ring 31-808-3595
- Adaptor for D-Torch B19 31-808-3651
- Adaptor for D-Torch B13 31-808-3596
- Metal Ball Joint Clip JC-19
- Safety Gloves, Medium SAFEGLOVE-med

Options:

Sheath Gas Adaptor 21-809-4083



Tapered Injectors for D-Torch

- Quartz Injector 1.0mm 31-808-0009
- Quartz Injector 1.2mm 31-808-3643
- Quartz Injector 1.5mm 31-808-0007
- Quartz Injector 1.8mm 31-808-8146
- Quartz Injector 2.0mm 31-808-0008
- Quartz Injector 2.4mm 31-808-3541
- Quartz Injector 2.5mm 31-808-3645
- Alumina Injector 1.0mm 31-808-0835
- Alumina Injector 1.5mm 31-808-0013
- Alumina Injector 1.8mm 31-808-0015
- Alumina Injector 2.0mm 31-808-0027
- Alumina Injector 2.4mm 31-808-0385



Capillary Injectors for D-Torch

Alumina Injector 1.8mm 31-808-0087

Spectro™ Torch 31-808-3405



Injectors for Quartz Torch

- Quartz Injector 1.0mm 31-808-4148
- Quartz Injector 1.2mm 31-808-3410
- Quartz Injector 1.5mm 31-808-4234
- Quartz Injector 1.8mm 31-808-3391
- Quartz Injector 2.0mm 31-808-3411
- Quartz Injector 2.5mm 31-808-4235
- Quartz Injector 3.0mm 31-808-3412
- Alumina Injector 1.8mm 31-808-3409
- Alumina Injector 2.5mm 31-808-3390



Common Accessories

Elegra Argon Humidifier

Elegra Argon Humidifier 70-803-1269



Elegra Stand 70-803-1581



Guardian In-Line Filters

- Guardian DC in-line non-return gas filter 70-803-1942
- Guardian in-line sample filter 70-803-1108



Trident Internal Standard Kits

- Trident CT Standard Kit 60-703-1179
- Standard Kit for HF 60-808-1150



Autosampler Probes

(See page 14 for complete list of probes)

For Cetac ASX-520

- Polyimide sheathed Autosampler Probe 0.5mm ID 60-808-1186L
- PTFE Encapsulated Carbon Fibre Probe 0.5mm ID 70-803-0784
- PTFE Encapsulated Carbon Fibre Probe 0.75mm ID 70-803-1443
- PTFE Encapsulated Carbon Fibre Probe 1.0mm ID 70-803-0793



Glass DC Nebulizers

SeaSpray

400µL/min uptake A31-1-USS04X

MicroMist

400µL/min uptake A31-1-UM04X

200µL/min uptake A31-1-UM02X

100µL/min uptake A31-1-UM01Q

50µL/min uptake A31-1-UM005Q



Quartz DC Nebulizers

SeaSpray

1mL/min uptake A31-1-QSS1



DC Nebulizers for HF

OpalMist

400µL/min uptake A31-1-PFA04X

200µL/min uptake A31-1-PFA02X

100µL/min uptake A31-1-PFA01Q

50µL/min uptake A31-1-PFA005Q



IsoMist XR

Programmable Temperature Cyclonic Spray Chamber

Glass Spray chamber KT-1027-XR

Quartz spray chamber KT-1027Q-XR

PFA spray chamber KT-1027P-XR

Elbow Adaptor with gas port 21-809-4155



Torches

Quartz Torch

Base for Q Torch 31-808-3494

Quartz Torch Body for Q 31-808-3357

Torch Options:

Quartz Injector 1.0mm 31-808-3440

Quartz Injector 2.0mm 31-808-3898

Quartz Injector 2.5mm 31-808-3428



Cones

Sampler Cones

Nickel Sampler with Copper Core TG1021-Ni/Cu

Aluminium Sampler TG1021-Al

Platinum Sampler with Copper Core TG1026A-Pt/Cu



Skimmer Cones

Nickel Skimmer Hot and Cold Plasma TG1035-Ni

Platinum Skimmer Hot and Cold Plasma TG1039-Pt



Nickel Skimmer (High Matrix) TG1044-Ni

Eliminates need for insert.



Platinum Skimmer (High Matrix) TG1048-Pt

Eliminates need for insert.



Graphite Sampler Cone Gasket

TG5001

Common Accessories

Elegra Argon Humidifier

Elegra Argon Humidifier 70-803-1303



Guardian In-Line Filters

Guardian DC in-line non-return gas filter 70-803-1942

Guardian in-line sample filter 70-803-1108



Trident Internal Standard Kits

Trident CT Standard Kit 60-703-1179

Standard Kit for HF 60-808-1150



Autosampler Probes

(See page 14 for complete list of probes)

For Cetac ASX-520

Polyimide sheathed Autosampler Probe
0.5mm ID 60-808-1186L

PTFE Encapsulated Carbon Fibre Probe
0.5mm ID 70-803-0784

PTFE Encapsulated Carbon Fibre Probe
0.75mm ID 70-803-1443

PTFE Encapsulated Carbon Fibre Probe
1.0mm ID 70-803-0793



Glass DC Nebulizers

SeaSpray

2mL/min uptake	A31-07-USS2
400µL/min uptake	A31-07-USS04

MicroMist

600µL/min uptake	A31-07-UM06
200µL/min uptake	A31-07-UM02
100µL/min uptake	A31-07-UM01
50µL/min uptake	A31-07-UM005



Conikal

2mL/min uptake	A31-07-UC2
1mL/min uptake	A31-07-UC1

Slurry

4mL/min uptake	A31-07-US6
----------------	------------

DC Nebulizers for HF

DuraMist

1mL/min uptake	A31-07-DM1
400µL/min uptake	A31-07-DM04



OpalMist

2mL/min uptake	A31-07-PFA2
600µL/min uptake	A31-07-PFA06
200µL/min uptake	A31-07-PFA02
100µL/min uptake	A31-07-PFA01
50µL/min uptake	A31-07-PFA005



VeeSpray

0.6 - 3mL/min uptake	A31-07-CV6
----------------------	------------



IsoMist XR

Programmable Temperature Cyclonic Spray Chamber

Glass Spray Chamber	KT-1166-XR
---------------------	------------



Spray Chambers

HydraMist Simultaneous Cold Vapor/ Pneumatic Nebulization Spray Chamber

Hydride Kit	KT-1160
-------------	---------



Spray Chambers

Tracey

50mL Cyclonic	20-809-2665HE
---------------	---------------



Twister

50mL Cyclonic	20-809-2951HE
---------------	---------------



Straight Ball Joint Adaptor

21-809-2723



Spray Chambers for HF

Tracey TFE

50mL Cyclonic	20-809-9198
---------------	-------------



Torches

D-Torch

30-808-4150

Comprises:

Base and Inner Tube	31-808-4125
Quartz Outer Tube with slot	31-808-4152



D-Torch Options:

Ceramic Outer Tube with slot	31-808-3996
------------------------------	-------------



Retaining Ring	31-808-2707
----------------	-------------

Injector Adaptor	31-808-2895
------------------	-------------

Injector Ferrule	31-808-2897
------------------	-------------

Torches

D-Torch

D-Torch Options:

- PTFE Coated
- Viton O-rings (PKT 10) VT-007



Quartz Torch

- EMT Design 31-808-4158

Tapered Injectors for D-Torch & EMT Torch

- Quartz Injector 0.75mm 31-808-3511
- Quartz Injector 1.0mm 31-808-2833
- Quartz Injector 1.5mm 31-808-2834
- Alumina Injector 2.0mm 31-808-3984



Capillary Injectors for D-Torch & EMT Torch

- Quartz Injector 1.0mm 31-808-3510
- Quartz Injector 2.0mm 31-808-2836
- Quartz Injector 2.5mm 31-808-3246
- Quartz Injector 3.0mm 31-808-3247
- Alumina Injector 1.0mm 31-808-3279
- Alumina Injector 2.0mm 31-808-2835
- Sapphire Injector 2.0mm 31-808-2977



Autosampler Probes

(See page 14 for complete list of probes)

For Cetac ASX-520

- Polyimide sheathed Autosampler Probe 0.5mm ID 60-808-1186L
- PTFE Encapsulated Carbon Fibre Probe 0.5mm ID 70-803-0784
- PTFE Encapsulated Carbon Fibre Probe 0.75mm ID 70-803-1443
- PTFE Encapsulated Carbon Fibre Probe 1.0mm ID 70-803-0793



Common Accessories

Elegra Argon Humidifier

- Elegra Argon Humidifier 70-803-1303



Guardian In-Line Filters

- Guardian DC in-line non-return gas filter 70-803-1942
- Guardian in-line sample filter 70-803-1108



Trident Internal Standard Kits

- Trident CT Standard Kit 60-703-1179
- Standard Kit for HF 60-808-1150



Glass DC Nebulizers

SeaSpray

2mL/min uptake	A31-07-USS2
400µL/min uptake	A31-07-USS04

MicroMist

600µL/min uptake	A31-07-UM06
200µL/min uptake	A31-07-UM02
100µL/min uptake	A31-07-UM01
50µL/min uptake	A31-07-UM005



Conikal

2mL/min uptake	A31-07-UC2
1mL/min uptake	A31-07-UC1

Slurry

4mL/min uptake	A31-07-US6
----------------	------------

DC Nebulizers for HF

DuraMist

1mL/min uptake	A31-07-DM1
400µL/min uptake	A31-07-DM04



OpalMist

2mL/min uptake	A31-07-PFA2
600µL/min uptake	A31-07-PFA06
200µL/min uptake	A31-07-PFA02
100µL/min uptake	A31-07-PFA01
50µL/min uptake	A31-07-PFA005



VeeSpray

0.6 - 3mL/min uptake	A31-07-CV6
----------------------	------------



IsoMist XR

Programmable Temperature Cyclonic Spray Chamber

Glass Spray chamber	KT-1166-XR
---------------------	------------



Spray Chambers

HydraMist Simultaneous Cold Vapor/ Pneumatic Nebulization Spray Chamber

Hydride Kit	KT-1160
-------------	---------



Spray Chambers

Tracey

50mL Cyclonic	20-809-2665HE
---------------	---------------



Twister

50mL Cyclonic	20-809-2951HE
---------------	---------------



Straight Ball Joint Adaptor

21-809-2723



Spray Chambers for HF

Tracey TFE

50mL Cyclonic	20-809-9198
---------------	-------------



Torches

D-Torch

30-808-2877



Comprises:

Base and Inner Tube	31-808-2932
Quartz Outer Tube	31-808-2878

D-Torch Options:

Ceramic Outer Tube	31-808-3836
--------------------	-------------



PTFE Coated	
Viton O-rings (PKT 10)	VT-007
Viton O-rings (PKT 10)	V-026
O-ring kit	70-803-1520
Retaining Ring	31-808-2707
Injector Adaptor	31-808-2895
Injector Ferrule	31-808-2897



Torches

Quartz Torch

EMT Design 31-808-2810



Tapered Injectors for D-Torch & EMT Torch

Quartz Injector 0.75mm 31-808-3511
 Quartz Injector 1.0mm 31-808-2833
 Quartz Injector 1.5mm 31-808-2834
 Alumina Injector 2.0mm 31-808-3984



Capillary Injectors for D-Torch & EMT Torch

Quartz Injector 1.0mm 31-808-3510
 Quartz Injector 2.0mm 31-808-2836
 Quartz Injector 2.5mm 31-808-3246
 Quartz Injector 3.0mm 31-808-3247
 Alumina Injector 1.0mm 31-808-3279
 Alumina Injector 2.0mm 31-808-2835
 Sapphire Injector 2.0mm 31-808-2977



Autosampler Probes

(See page 14 for complete list of probes)

For Cetac ASX-520

Polyimide sheathed Autosampler Probe
 0.5mm ID 60-808-1186L
 PTFE Encapsulated Carbon Fibre Probe
 0.5mm ID 70-803-0784
 PTFE Encapsulated Carbon Fibre Probe
 0.75mm ID 70-803-1443
 PTFE Encapsulated Carbon Fibre Probe
 1.0mm ID 70-803-0793



Common Accessories

Elegra Argon Humidifier

Elegra Argon Humidifier 70-803-1303



Guardian In-Line Filters

Guardian DC in-line non-return
 gas filter 70-803-1942
 Guardian in-line sample filter 70-803-1108



Trident Internal Standard Kits

Trident CT Standard Kit 60-703-1179
 Standard Kit for HF 60-808-1150



Glass DC Nebulizers

SeaSpray

2mL/min uptake	A31-07-USS2
400µL/min uptake	A31-07-USS04

MicroMist

600µL/min uptake	A31-07-UM06
200µL/min uptake	A31-07-UM02
100µL/min uptake	A31-07-UM01
50µL/min uptake	A31-07-UM005



Conikal

2mL/min uptake	A31-07-UC2
1mL/min uptake	A31-07-UC1

Slurry

4mL/min uptake	A31-07-US6
----------------	------------

DC Nebulizers for HF

DuraMist

1mL/min uptake	A31-07-DM1
400µL/min uptake	A31-07-DM04



OpalMist

2mL/min uptake	A31-07-PFA2
600µL/min uptake	A31-07-PFA06
200µL/min uptake	A31-07-PFA02
100µL/min uptake	A31-07-PFA01
50µL/min uptake	A31-07-PFA005



VeeSpray

0.6 - 3mL/min uptake	A31-07-CV6
----------------------	------------



IsoMist XR

Programmable Temperature Cyclonic Spray Chamber

Glass Spray Chamber	KT-1015-XR
Quartz Spray Chamber	KT-1015Q-XR
PFA Spray Chamber	KT-1015P-XR



Spray Chambers

HydraMist Simultaneous Cold Vapor/ Pneumatic Nebulization Spray Chamber

Thermo® Duo 7600 Hydride Kit	KT-1156
Thermo Duo® 6000/7200/7400 Hydride Kit	KT-1179



Spray Chambers

Tracey

50mL Cyclonic	20-809-2665HE
---------------	---------------



Twister

50mL Cyclonic	20-809-2951HE
---------------	---------------



Adaptor

Right Angle With Ball Joint	21-809-2761
-----------------------------	-------------



Spray Chambers for HF

Tracey TFE

50mL Cyclonic	20-809-3469
---------------	-------------



Torches

D-Torch

30-808-2844

Comprises:

Base and Inner Tube	31-808-2932
Quartz Outer Tube	31-808-2840



D-Torch Options:

Ceramic Outer Tube	31-808-3834
Optic Fibre 170mm	31-808-2933
Optic Fibre 450mm	31-808-3117
Retaining Ring	31-808-2707
Injector Adaptor	31-808-2895
Injector Ferrule	31-808-2897



Torches

D-Torch

D-Torch Options:

PTFE Coated
Viton O-rings (PKT 10) VT-007



Ceramic Outer Tube and Optic Fibre for D-Torch

31-808-3079

Comprises:

Ceramic Outer Tube 31-808-3834
Optic Fibre 170mm 31-808-2933
Optic Fibre 450mm 31-808-3117



Quartz Torch

EMT Design 31-808-2811



Tapered Injectors for D-Torch & EMT Torch

Quartz Injector 1.0mm 31-808-2833
Quartz Injector 1.5mm 31-808-2834



Capillary Injectors for D-Torch & EMT Torch

Quartz Injector 2.0mm 31-808-2836
Quartz Injector 2.5mm 31-808-3246
Quartz Injector 3.0mm 31-808-3247
Alumina Injector 1.0mm 31-808-3279
Alumina Injector 2.0mm 31-808-2835
Sapphire Injector 2.0mm 31-808-2977



Duo Periscope Window

31-808-2677

O-ring for Periscope Window (PKT 10) 70-803-1603



Quartz Window

70-803-1116



Purged Optical Path (POP) Assembly

70-803-1571

Window & O-Ring for Purged Optical Path (POP) 70-803-1892



RF Coils

RF Coil for 6000

Silver, Teflon Coated 70-900-4002S
Gold, Teflon Coated 70-900-4002G

RF Coil for 7000/6000 Mark II

Silver, Teflon Coated 70-900-4005S
Gold, Teflon Coated 70-900-4005G

RF Coil Installation Kit 70-900-4002T



Common Accessories

Elegra Argon Humidifier

Elegra Argon Humidifier 70-803-1303



Guardian In-Line Filters

Guardian DC in-line non-return gas filter 70-803-1942
Guardian in-line sample filter 70-803-1108



Trident Internal Standard Kits

Trident CT Standard Kit 60-703-1179
Standard Kit for HF 60-808-1150



Autosampler Probes

(See page 14 for complete list of probes)

For Cetac ASX-520

Polyimide sheathed Autosampler Probe 0.5mm ID 60-808-1186L
PTFE Encapsulated Carbon Fibre Probe 0.5mm ID 70-803-0784
PTFE Encapsulated Carbon Fibre Probe 0.75mm ID 70-803-1443
PTFE Encapsulated Carbon Fibre Probe 1.0mm ID 70-803-0793



Glass DC Nebulizers

SeaSpray

2mL/min uptake	A31-07-USS2
400µL/min uptake	A31-07-USS04

MicroMist

600µL/min uptake	A31-07-UM06
200µL/min uptake	A31-07-UM02
100µL/min uptake	A31-07-UM01
50µL/min uptake	A31-07-UM005



Conikal

2mL/min uptake	A31-07-UC2
1mL/min uptake	A31-07-UC1

Slurry

4mL/min uptake	A31-07-US6
----------------	------------

DC Nebulizers for HF

DuraMist

1mL/min uptake	A31-07-DM1
400µL/min uptake	A31-07-DM04



OpalMist

2mL/min uptake	A31-07-PFA2
600µL/min uptake	A31-07-PFA06
200µL/min uptake	A31-07-PFA02
100µL/min uptake	A31-07-PFA01
50µL/min uptake	A31-07-PFA005



VeeSpray

0.6 - 3mL/min uptake	A31-07-CV6
----------------------	------------



IsoMist XR

Programmable Temperature Cyclonic Spray Chamber

Glass Spray chamber	KT-1021-XR
PFA spray chamber	KT-1021P-XR
Twinnabar spray chamber	KT-1021T-XR



Spray Chambers

Tracey

50mL Cyclonic	20-809-2665HE
---------------	---------------



Twister

50mL Cyclonic	20-809-2951HE
---------------	---------------



Straight Ball Joint Adaptor

21-809-2723



Spray Chambers for HF

Tracey TFE

50mL Cyclonic	20-809-9198
---------------	-------------



Torches

D-Torch

30-808-2877

Comprises:

Base and Inner Tube	31-808-2932
Quartz Outer Tube	31-808-2878
Retaining Ring	31-808-2707
Injector Adaptor	31-808-2895
Injector Ferrule	31-808-2897



D-Torch Options:

Ceramic Outer Tube	31-808-3836
--------------------	-------------



PTFE Coated	
Viton O-rings (PKT 10)	VT-007
Viton O-rings (PKT 10)	V-026
O-ring kit	70-803-1520



Torches

Quartz Torch

EMT Design 31-808-2810



Tapered Injectors for D-Torch & EMT Torch

Quartz Injector 1.0mm 31-808-2833



Quartz Injector 1.5mm 31-808-2834

Capillary Injectors for D-Torch & EMT Torch

Quartz Injector 2.0mm 31-808-2836

Alumina Injector 1.0mm 31-808-3279

Alumina Injector 2.0mm 31-808-2835

Sapphire Injector 2.0mm 31-808-2977



RF Coils

RF Coil for 6000 Mark I

Silver, Teflon Coated 70-900-4002S

Gold, Teflon Coated 70-900-4002G



RF Coil for 7000/6000 Mark II

Silver, Teflon Coated 70-900-4005S

Gold, Teflon Coated 70-900-4005G



RF Coil Installation Kit 70-900-4002T



Common Accessories

Elegra Argon Humidifier

Elegra Argon Humidifier 70-803-1303



Guardian In-Line Filters

Guardian DC in-line non-return gas filter 70-803-1942

Guardian in-line sample filter 70-803-1108



Common Accessories

(continued)

Trident Internal Standard Kits

Trident CT Standard Kit 60-703-1179

Standard Kit for HF 60-808-1150



Autosampler Probes

(See page 14 for complete list of probes)

For Cetac ASX-520

Polyimide sheathed Autosampler Probe
0.5mm ID 60-808-1186L

PTFE Encapsulated Carbon Fibre Probe
0.5mm ID 70-803-0784

PTFE Encapsulated Carbon Fibre Probe
0.75mm ID 70-803-1443

PTFE Encapsulated Carbon Fibre Probe
1.0mm ID 70-803-0793



DC Nebulizer Gas Fitting Connectors

Agilent® Vista/700-ES	70-803-0969
Agilent® MP-AES	70-803-0969
Agilent® 4500/7500	70-803-1086
Agilent® 7700/7800/7900/8800/8900	70-803-1105
Agilent® 5100/5110/5800/5900	70-803-1105
Analytik Jena® ICP-MS	70-803-0969
Analytik Jena® ICP-OES	70-803-1105
Horiba® Jobin Yvon (All models)	70-803-1105
Leeman (All models)	70-803-0969
Nu Instruments ICP-MS	70-803-1858
PerkinElmer® Optima and Avio	70-803-1070
PerkinElmer® Elan/NexION 300/350	70-803-1049
PerkinElmer® NexION 1000/2000	70-803-1449
Shimadzu® 9000/9800	70-803-1311
Shimadzu® 2030	70-803-1311
Spectro™ (All models)	70-803-1070
Thermo® 6000/7000/Q & X-Series	70-803-1292
Thermo® Neptune	70-803-1468
Elegra to DC Nebulizer	70-803-1278
1/4-28F to 1mm OD gas inlet	70-803-1504

LC Interface for Speciation Measurements

The high-pressure fitting kit is a quick and easy way to ensure a leak tight connection of 1/16" or 1.3mm OD sample capillary to a Glass Expansion concentric nebulizer such as the SeaSpray, Conikal, MicroMist, DuraMist or OpalMist nebulizers. If you need to make a leak tight seal to your nebulizer - whether it is to a HPLC for speciation or a high throughput switching valve use this kit.

High Pressure nebulizer fitting kit	FT-16-8-X
Tefzel Ferrule 1/8 inch (PKT 10)	70-803-1513
Tefzel Ferrule 1/16 inch (PKT 10)	70-803-1315

EzyLok Kit for Nebulizer Gas Side Arm

EzyLok Kit	EL-1
Comprises:	
EzyLok Connector for 4mm Tubing	QSM-4
EzyLok 6mm Hose Adaptor	70-808-0735
Hose Clip, 6mm	SNP-1



Tubing Connector

1.3mm to 1/16 inch	FT-16-1.3
1/16 inch to 1/16 inch	FT-16-1.6

Sample Tube Connectors (PKT 10)

	UniFit P/N	EzyFit P/N
0.25mm ID x 1.27mm OD x 700mm long	NFT-025	EZT-025
0.25mm ID x 1.27mm OD x 2000mm long	NFT2-025	EZT2-025
0.50mm ID x 1.27mm OD x 700mm long	NFT-050	EZT-050
0.50mm ID x 1.27mm OD x 2000mm long	NFT2-050	EZT2-050
0.75mm ID x 1.27mm OD x 700mm long	NFT-075	EZT-075
0.75mm ID x 1.27mm OD x 2000mm long	NFT2-075	EZT2-075
0.75mm ID x 1.27mm OD x 1500mm long	NFTS-075	EZTS-075
0.07mm ID x 1/16" OD x 700mm long	NFT-16-07	EZT-16-07
0.13mm ID x 1/16" OD x 700mm long	NFT-16-13	EZT-16-13
0.18mm ID x 1/16" OD x 700mm long	NFT-16-18	EZT-16-18
0.25mm ID x 1/16" OD x 700mm long	NFT-16-25	EZT-16-25
0.25mm ID x 1/16" OD x 1500mm long	NFTS-16-25	EZTS-16-25
0.50mm ID x 1/16" OD x 700mm long	NFT-16-50	EZT-16-50
0.50mm ID x 1/16" OD x 1500mm long	NFTS-16-50	EZTS-16-50
0.75mm ID x 1/16" OD x 700mm long	NFT-16-75	EZT-16-75
0.75mm ID x 1/16" OD x 1500mm long	NFTS-16-75	EZTS-16-75
Tefzel 0.5mm ID x 1.3mm OD x 700mm long	NFTFE-050	EZTFE-050
0.3mm ID x 0.75mm OD x 700mm long	NFT-0703	EZT-0703

Sample Tubing

0.25mm ID x 1.27mm OD x 10m long	STT-025
0.50mm ID x 1.27mm OD x 10m long	STT-050
0.75mm ID x 1.27mm OD x 10m long	STT-075
0.25mm ID x 1/16" OD x 10m long	STT-16-25
0.50mm ID x 1/16" OD x 10m long	STT-16-50
0.75mm ID x 1/16" OD x 10m long	STT-16-75
1.0mm ID x 1/16" OD x 10m long	STT-16-100
0.3mm ID x 0.75mm OD x 10m long	STT-0703
0.13mm ID x 1.27mm OD x 10m long	PFT-013
0.18mm ID x 1.27mm OD x 10m long	PFT-018
0.07mm ID x 1/16" OD x 10m long	PFT-16-07
0.13mm ID x 1/16" OD x 10m long	PFT-16-13
0.18mm ID x 1/16" OD x 10m long	PFT-16-18
1/8" ID x 1/4" OD x 1m long	1/4PFA-HW
Tefzel 0.5mm ID x 1.3mm OD x 10m long	TFE-050

Other Tubing

Reagent tube 1.6mm OD x 1.0mm ID x 1400mm long with PTFE Sinkers (PKT. 3)	70-803-0752
Tygon Tubing 1/4 inch x 1m	1921-1M
Tygon Tubing 700mm	70-803-0598

Helix & Helix CT Spray Chambers

Helix CT:

Helix CT Locking Screw with Seal	70-803-1439
Helix CT For MiraMist	70-803-1470
Helix CT Seal (PKT 4)	70-803-1456

Helix:

Helix Locking Screw	70-100-0152
Helix Seal (PKT 4)	70-100-0237
Nebulizer Spacer	21-100-0246



O-Rings Spray Chambers

O-ring set for Large Adaptor (Tracey, Twister)	70-808-0501
O-ring set for Small Adaptor (Cinnabar, Twinnabar)	21-808-0818
Teflon coated Viton O-Rings for spray chamber, nebulizer seal (PKT 10)	VT-009
Teflon coated Viton O-Rings for spray chamber, 16mm large adaptor seal (PKT 10)	VT-10/2
Silicon o-rings for spray chamber, nebulizer seal (PKT 10)	S-009

GazFit Connectors for Torches

GazFit Connectors (PKT 2), for 8mm OD arm	GAZ-08
GazFit Connectors (PKT 4), for 6mm OD torch side arms	GAZ-06
GazFit Connectors (PKT 4), 2 for 6mm OD torch side arms, 2 for 4mm OD torch side arms	GAZ-0604
GazFit Connectors (PKT 4), for 5mm OD torch side arms	GAZ-05
GazFit Connectors (PKT 4), for 4mm OD torch side arms	GAZ-04

GazFit connectors are only suitable for torches with tolerances of no more than +/- 0.15mm on the diameter of the side arms.

All Glass Expansion torches meet this specification.



Clips & Connectors for Spray Chambers

Metal Ball Joint Clip (to connect spray chamber and torch)	JC-13
Nickel Joint Clip B14 (to connect spray chamber and drain adaptors)	KCM-14
Nickel Joint Clip KCM29 (to connect spray chamber and drain adaptors)	KCM-29
UniFit Connector with sample tube, 0.75mm ID x 1/16" OD x 700mm long (PKT 3)	UFT-16-75
UniFit Connector with sample tube, 0.75mm ID x 1.3mm OD x 700mm long (PKT 3)	UFT-075
UniFit Connector with sample tube, 0.86mm ID x 2mm OD x 480mm long (PKT 3)	UFT-2-86
UniFit Connector with sample tube, 0.86mm ID x 2mm OD x 700mm long (PKT 3)	UFT-2-700
Connector Assembly for Agilent® Scott Spray Chamber	70-803-1476
HydraMist Drain (PKT 4)	GAZ-08-4



O-Rings for Torches

Viton O-Rings for demountable torch ball joint connectors (PKT 10)	70-V-011
---	----------

PVC Peristaltic Pump Tubing

All tubes made from Tygon R3603/R3607 or equivalent. Supplied in packs of 12 tubes.

Special Properties:

- Inexpensive all-round tubing for general laboratory applications.

Advantages:

- Resistant to almost all inorganic materials.
- Does not age.
- Low gas permeability.
- Smooth inner surface.

Limitations:

- Potential leaching of plasticizers.

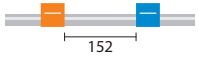

PVC, 2 Bridged, 152mm (152mm between tags)

Tag Colours	ID (mm)	P/N
orange/black	0.13	0.13-OBLK
orange/red	0.19	0.19-OR
orange/blue	0.25	0.25-OB
orange/green	0.38	0.38-OG
green/yellow	0.44	0.44-GY
orange/yellow	0.51	0.51-OY
white/yellow	0.57	0.57-WY
orange/white	0.64	0.64-OW
black/black	0.76	0.76-BLK
orange/orange	0.89	0.89-ORG
white/black	0.95	0.95-WBLK
white/white	1.02	1.02-WHT
white/red	1.09	1.09-WR
red/red	1.14	1.14-RED
red/grey	1.22	1.22-RGRY
grey/grey	1.30	1.30-GRY
yellow/yellow	1.42	1.42-YLW
yellow/blue	1.52	1.52-YB
blue/blue	1.65	1.65-BLU
blue/green	1.75	1.75-BG
green/green	1.85	1.85-GRN
purple/purple	2.06	2.06-PUR
purple/black	2.29	2.29-PBLK
purple/orange	2.54	2.54-PO
purple/white	2.79	2.79-PW
black/white	3.17	3.17-BLKW

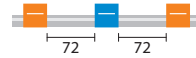

PVC, 3 Bridged, 72mm (72mm between tags)

Tag Colours	ID (mm)	P/N
orange/black	0.13	0.13-OBLK3B
orange/red	0.19	0.19-OR3B
orange/blue	0.25	0.25-OB3B
orange/green	0.38	0.38-OG3B
green/yellow	0.44	0.44-GY3B
orange/yellow	0.51	0.51-OY3B
white/yellow	0.57	0.57-WY3B
orange/white	0.64	0.64-OW3B
black/black	0.76	0.76-BLK3B
orange/orange	0.89	0.89-ORG3B
white/black	0.95	0.95-WBLK3B
white/white	1.02	1.02-WHT3B
white/red	1.09	1.09-WR3B
red/red	1.14	1.14-RED3B
red/grey	1.22	1.22-RGRY3B
grey/grey	1.30	1.30-GRY3B
yellow/yellow	1.42	1.42-YLW3B
yellow/blue	1.52	1.52-YB3B
blue/blue	1.65	1.65-BLU3B
green/green	1.85	1.85-GRN3B
purple/purple	2.06	2.06-PUR3B
purple/black	2.29	2.29-PBLK3B
purple/orange	2.54	2.54-PO3B
purple/white	2.79	2.79-PW3B
black/white	3.17	3.17-BLKW3B

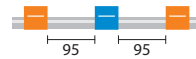

PVC, 3 Bridged, 95mm (95mm between tags)

Tag Colours	ID (mm)	P/N
orange/blue	0.25	0.25-OB3B-95
orange/green	0.38	0.38-OG3B-95
orange/yellow	0.51	0.51-OY3B-95
orange/white	0.64	0.64-OW3B-95
black/black	0.76	0.76-BLK3B-95
orange/orange	0.89	0.89-ORG3B-95
white/white	1.02	1.02-WHT3B-95
grey/grey	1.30	1.30-GRY3B-95
yellow/blue	1.52	1.52-YB3B-95
green/green	1.85	1.85-GRN3B-95
purple/white	2.79	2.79-PW3B-95

Solva Peristaltic Pump Tubing

All tubes made from Tygon 4040 or equivalent. Supplied in packs of 12 tubes.

Special Properties:

- Special tubing for hydrocarbons, petroleum products and distillates.

Advantages:

- Specially formulated to transport hydrocarbons, petroleum products and distillates.
- Ideal for gasoline, kerosene, heating oils, cutting liquids and coolants based on glycols.
- Low gas permeability.

Limitations:

- Not recommended for strong acids and alkalies, foodstuffs, beverages and medicines.
- Potential leaching of plasticizers.

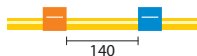

Solva, 2 Bridged, 140mm (140mm between tags)

Tag Colours	ID (mm)	P/N
	0.25	0.25-OB-SF
	0.38	0.38-OG-SF
	0.51	0.51-OY-SF
	0.64	0.64-OW-SF
	0.76	0.76-BLK-SF
	0.89	0.89-ORG-SF
	1.02	1.02-WHT-SF
	1.14	1.14-RED-SF
	1.30	1.30-GRY-SF
	1.42	1.42-YLW-SF
	1.52	1.52-YB-SF
	1.65	1.65-BLU-SF
	1.85	1.85-GRN-SF
	2.06	2.06-PUR-SF
	2.29	2.29-PBLK-SF
	2.54	2.54-PO-SF
	2.79	2.79-PW-SF

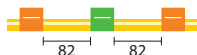

Solva, 3 Bridged, 82mm (82mm between tags)

Tag Colours	ID (mm)	P/N
	0.38	0.38-OG3B-SF
	0.76	0.76-BLK3B-SF
	0.89	0.89-ORG3B-SF
	1.14	1.14-RED3B-SF
	1.30	1.30-GRY3B-SF

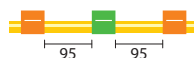

Solva, 3 Bridged, 95mm (95mm between tags)

Tag Colours	ID (mm)	P/N
	0.38	0.38-OG3B-95-SF
	0.51	0.51-OY3B-95-SF
	0.76	0.76-BLK3B-95-SF
	0.89	0.89-ORG3B-95-SF
	1.02	1.02-WHT3B-95-SF
	1.52	1.52-YB3B-95-SF

Viton® Peristaltic Pump Tubing

All tubes made from Fluran HC F-5500-A or equivalent.

Special Properties:

- Special tubing for concentrated acids and corrosive solvents.

Advantages:

- High chemical resistance.
- Low gas permeability.
- Wide temperature range.

Limitations:

- Limited service life.

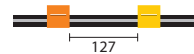

Viton®, 2 Bridged, 127mm (127mm between tags)

Tag Colours	ID (mm)	P/N
	0.51	VS0.51-OY
	0.64	VS0.64-OW
	0.76	VS0.76-BLK
	0.89	VS0.89-ORG
	1.02	VS1.02-WHT
	1.14	VS1.14-RED
	1.30	VS1.30-GRY
	1.42	VS1.42-YLW
	1.52	VS1.52-YB
	1.65	VS1.65-BLU
	1.85	VS1.85-GRN
	2.06	VS2.06-PUR
	2.29	VS2.29-PBLK
	2.54	VS2.54-PO
	2.79	VS2.79-PW

Supplied in packs of 12 tubes

Tygon® MH Peristaltic Pump Tubing

All tubes made from Tygon MHSL 2001.

Special Properties:

- Environmental-friendly tubing especially designed for solvents.
- Suitable for MIBK.

Advantages:





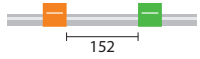

- High chemical resistance.
- Low gas permeability.
- Wide temperature range.

Limitations:

- Limited service life.









Tygon® MH, 2 Bridged, 152mm (152mm between tags)

Tag Colours	ID (mm)	P/N	
	orange/green	0.38	0.38-ORG-MH
	orange/white	0.64	0.64-OW-MH
	white/white	1.02	1.02-WHT-MH
	yellow/blue	1.52	1.52-YB-MH
	purple/purple	2.06	2.06-PUR-MH
	purple/white	2.79	2.79-PW-MH

Supplied in packs of 6 tubes



Tygon® MH, 2 Bridged, 72mm (72mm between tags)

Tag Colours	ID (mm)	P/N	
	orange/green	0.38	0.38-ORG-MH3
	orange/white	0.64	0.64-OW-MH3
	white/white	1.02	1.02-WHT-MH3
	yellow/blue	1.52	1.52-YB-MH3
	purple/purple	2.06	2.06-PUR-MH3
	purple/white	2.79	2.79-PW-MH3

Supplied in packs of 6 tubes

Contour Flared-end Peristaltic Pump Tubing

It can be quite difficult to insert the sample tubing into the peristaltic pump tubes. This is particularly so for pump tubing with a small ID. To facilitate this connection, Glass Expansion supplies Contour flared-end pump tubing. The flared end of this pump tubing allows the larger capillary tubing to be inserted into the smaller pump tubing.

Any of the pump tubing that we normally supply can be supplied with flared end. Simply add "-F" to the end of the part number (eg. 0.38-OG-F). The flared-end tubing is supplied in packs of 6.

Contour Flared-end PVC Peristaltic Pump Tubing

All tubes made from Tygon R3603/R3607 or equivalent. Supplied in packs of 6 tubes.

Special Properties:

- Inexpensive all-round tubing for general laboratory applications.

Advantages:

- Transparent.
- Resistant to almost all inorganic materials.
- Does not age.
- Low gas permeability.
- Smooth inner surface.

Limitations:

- Potential leaching of plasticizers.



PVC, 2 Bridged, 152mm
(152mm between tags)

Tag Colours	ID (mm)	P/N
	0.13	0.13-OBLK-F
	0.19	0.19-OR-F
	0.25	0.25-OB-F
	0.38	0.38-OG-F
	0.44	0.44-GY-F
	0.51	0.51-OY-F
	0.57	0.57-WY-F
	0.64	0.64-OW-F
	0.76	0.76-BLK-F
	0.89	0.89-ORG-F
	0.95	0.95-WBLK-F
	1.02	1.02-WHT-F
	1.09	1.09-WR-F
	1.14	1.14-RED-F
	1.22	1.22-RGRY-F
	1.30	1.30-GRY-F
	1.42	1.42-YLW-F
	1.52	1.52-YB-F
	1.65	1.65-BLU-F
	1.75	1.75-BG-F
	1.85	1.85-GRN-F
	2.06	2.06-PUR-F
	2.29	2.29-PBLK-F
	2.54	2.54-PO-F
	2.79	2.79-PW-F
	3.17	3.17-BLKW-F

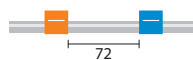

PVC, 2 Bridged, 72mm
(72mm between tags)

Tag Colours	ID (mm)	P/N
	0.19	0.19-OR-F-S
	0.25	0.25-OB-F-S
	0.76	0.76-BLK-F-S
	0.89	0.89-ORG-F-S

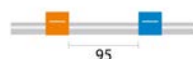

PVC, 2 Bridged, 95mm
(95mm between tags)

Tag Colours	ID (mm)	P/N
	0.19	0.19-OR-F-S
	0.25	0.25-OB-F-S
	0.38	0.38-OG-95-F-S
	0.44	0.44-GY-95-F-S
	0.51	0.51-OY-95-F-S
	0.64	0.64-OW-95-F-S
	0.76	0.76-BLK-95-F-S
	1.30	1.30-GRY-95-F-S

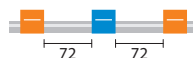

PVC, 3 Bridged, 72mm
(72mm between tags)

Tag Colours	ID (mm)	P/N
	0.13	0.13-OBLK3B-F
	0.19	0.19-OR3B-F
	0.25	0.25-OB3B-F
	0.38	0.38-OG3B-F
	0.44	0.44-GY3B-F
	0.51	0.51-OY3B-F
	0.57	0.57-WY3B-F
	0.64	0.64-OW3B-F
	0.76	0.76-BLK3B-F
	0.89	0.89-ORG3B-F
	0.95	0.95-WBLK3B-F
	1.02	1.02-WHT3B-F
	1.09	1.09-WR3B-F
	1.14	1.14-RED3B-F
	1.22	1.22-RGRY3B-F
	1.30	1.30-GRY3B-F
	1.42	1.42-YLW3B-F
	1.52	1.52-YB3B-F
	1.65	1.65-BLU3B-F
	1.85	1.85-GRN3B-F
	2.06	2.06-PUR3B-F
	2.29	2.29-PBLK3B-F
	2.54	2.54-PO3B-F
	2.79	2.79-PW3B-F
	3.17	3.17-BLKW3B-F

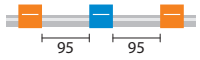

PVC, 3 Bridged, 95mm
(95mm between tags)

Tag Colours	ID (mm)	P/N
orange/blue	0.25	0.25-OB3B-95-F
orange/green	0.38	0.38-OG3B-95-F
orange/yellow	0.51	0.51-OY3B-95-F
black/black	0.76	0.76-BLK3B-95-F
orange/orange	0.89	0.89-ORG3B-95-F
white/white	1.02	1.02-WHT3B-95-F
grey/grey	1.30	1.30-GRY3B-95-F
yellow/blue	1.52	1.52-YB3B-95-F
green/green	1.85	1.85-GRN3B-95-F
purple/white	2.79	2.79-PW3B-95-F

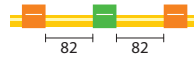

Solva, 3 Bridged, 82mm
(82mm between tags)

Tag Colours	ID (mm)	P/N
orange/green	0.38	0.38-OG3B-SF-F
black/black	0.76	0.76-BLK3B-SF-F
orange/orange	0.89	0.89-ORG3B-SF-F
red/red	1.14	1.14-RED3B-SF-F
grey/grey	1.30	1.30-GRY3B-SF-F

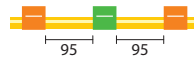

Solva, 3 Bridged, 95mm
(95mm between tags)

Tag Colours	ID (mm)	P/N
orange/green	0.38	0.38-OG3B-95-SF-F
orange/yellow	0.51	0.51-OY3B-95-SF-F
black/black	0.76	0.76-BLK3B-95-SF-F
orange/orange	0.89	0.89-ORG3B-95-SF-F
white/white	1.02	1.02-WHT3B-95-SF-F
yellow/blue	1.52	1.52-YB3B-95-SF-F

Contour Flared-end Solva Peristaltic Pump Tubing

All tubes made from Tygon 4040 or equivalent. Supplied in packs of 6 tubes.

Special Properties:

- Special tubing for hydrocarbons, petroleum products and distillates.

Advantages:

- Specially formulated to transport hydrocarbons, petroleum products and distillates.
- Ideal for gasoline, kerosene, heating oils, cutting liquids and coolants based on glycols.
- Low gas permeability.

Limitations:

- Not recommended for strong acids and alkalis, foodstuffs, beverages and medicines.
- Potential leaching of plasticizers.

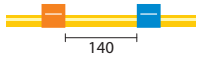

Solva, 2 Bridged, 140mm
(140mm between tags)

Tag Colours	ID (mm)	P/N
orange/blue	0.25	0.25-OB-SF-F
orange/green	0.38	0.38-OG-SF-F
orange/yellow	0.51	0.51-OY-SF-F
orange/white	0.64	0.64-OW-SF-F
black/black	0.76	0.76-BLK-SF-F
orange/orange	0.89	0.89-ORG-SF-F
white/white	1.02	1.02-WHT-SF-F
red/red	1.14	1.14-RED-SF-F
grey/grey	1.30	1.30-GRY-SF-F
yellow/yellow	1.42	1.42-YLW-SF-F
yellow/blue	1.52	1.52-YB-SF-F
blue/blue	1.65	1.65-BLU-SF-F
green/green	1.85	1.85-GRN-SF-F
purple/purple	2.06	2.06-PUR-SF-F
purple/black	2.29	2.29-PBLK-SF-F
purple/orange	2.54	2.54-PO-SF-F
purple/white	2.79	2.79-PW-SF-F

Contour Flared-end Viton® Peristaltic Pump Tubing

All tubes made from Fluran HC F-5500-A or equivalent.

Special Properties:

- Special tubing for concentrated acids and corrosive solvents.

Advantages:

- High chemical resistance.
- Low gas permeability.
- Wide temperature range.

Limitations:

- Limited service life.

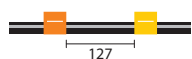

Viton®, 2 Bridged, 127mm (127mm between tags)

Tag Colours	ID (mm)	P/N
	0.51	VS0.51-OY-F
	0.64	VS0.64-OW-F
	0.76	VS0.76-BLK-F
	0.89	VS0.89-ORG-F
	1.02	VS1.02-WHT-F
	1.14	VS1.14-RED-F
	1.30	VS1.30-GRY-F
	1.42	VS1.42-YLW-F
	1.52	VS1.52-YB-F
	1.65	VS1.65-BLU-F
	1.85	VS1.85-GRN-F
	2.06	VS2.06-PUR-F
	2.29	VS2.29-PBLK-F
	2.54	VS2.54-PO-F
	2.79	VS2.79-PW-F

Supplied in packs of 6 tubes

Contour Flared-end Tygon® MH Peristaltic Pump Tubing

All tubes made from Tygon MHSL 2001.

Special Properties

- Environmental-friendly tubing especially designed for solvents.
- Suitable for MIBK.

Advantages:

- High chemical resistance.
- Low gas permeability.
- Wide temperature range.

Limitations:

- Limited service life.

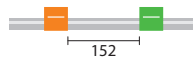

Tygon® MH, 2 Bridged, 152mm (152mm between tags)

Tag Colours	ID (mm)	P/N
	0.38	0.38-ORG-MH-F
	0.64	0.64-OW-MH-F
	1.02	1.02-WHT-MH-F
	1.52	1.52-YB-MH-F
	2.06	2.06-PUR-MH-F
	2.79	2.79-PW-MH-F

Supplied in packs of 6 tubes

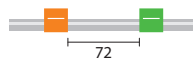

Tygon® MH, 2 Bridged, 72mm (72mm between tags)

Tag Colours	ID (mm)	P/N
	0.38	0.38-ORG-MH3-F
	0.64	0.64-OW-MH3-F
	1.02	1.02-WHT-MH3-F
	1.52	1.52-YB-MH3-F
	2.06	2.06-PUR-MH3-F
	2.79	2.79-PW-MH3-F

Supplied in packs of 6 tubes



International

6 Central Boulevard
Port Melbourne
Vic 3207, Australia

Telephone: +61 3 9320 1111
Facsimile: +61 3 9320 1112
Email: enquiries@geicp.com

Europe

Friedenbachstrasse 9
35781 Weilburg
Germany

Telephone: +49 6471 3778517
Email: gegmbh@geicp.com

Americas

31 Jonathan Bourne Drive, Unit 7
Pocasset, MA 02559, USA

Toll Free Phone: 800 208 0097
Telephone: 508 563 1800
Facsimile: 508 563 1802
Email: geusa@geicp.com

February 2022